

SKIPPER

DL850 (270 kHz) Operation and Installation Manual

2 Axis Doppler Navigational SOG + STW Speed Log

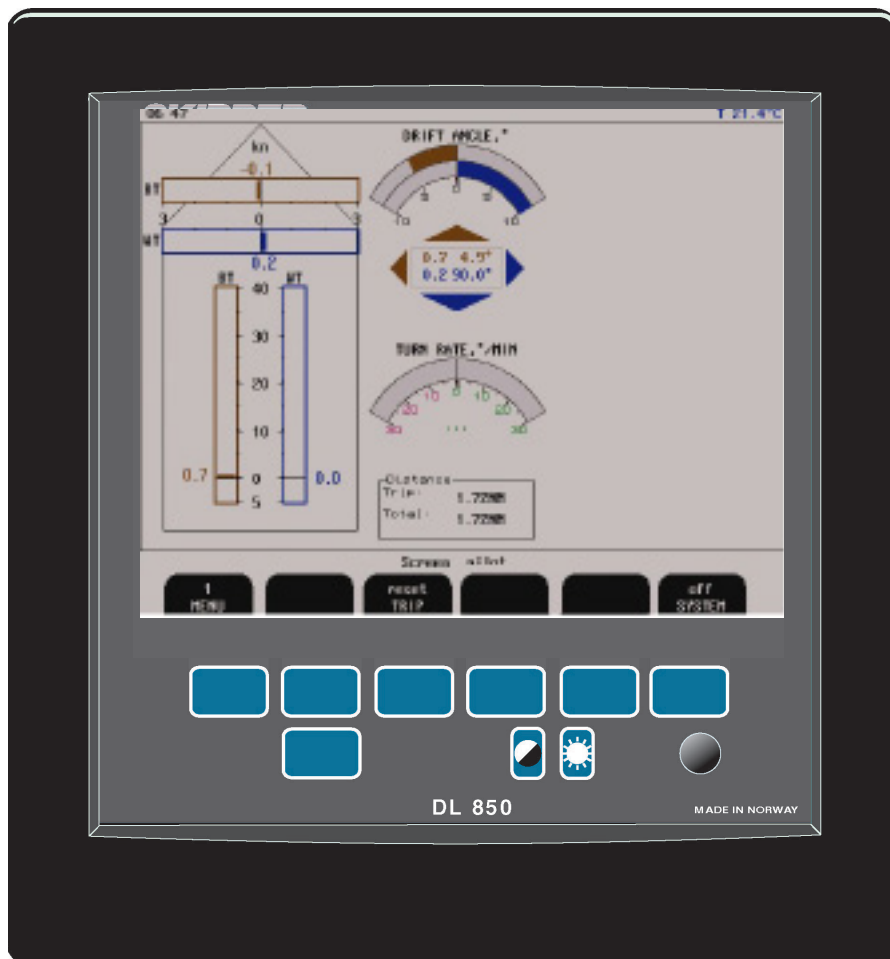

SKIPPER Electronics AS
Enebakkveien 150
P. O. Box 151, Manglerud
0612 Oslo, Norway
www.skipper.no

Telephone: +47 23 30 22 70
Telefax: +47 23 30 22 71
E-mail: support@skipper.no
Co. reg. no: NO-965378847-MVA

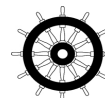

Document no: **DM-D002-SC**
Rev: 1650
For software ver: 4.04.01
Edition: 2017-09-25

Information:

Please visit our web site www.skipper.no for additional information. Here you will find product bulletins, software updates, instruction manuals, installation procedures etc.

Important

- During installation, **DO NOT CUT THE TRANSDUCER CABLE.** The transducer, transducer cable and transceiver cabinet are all “balanced parts”. Therefore cutting the cable may deteriorate performance and will also void the warranty.
- During installation, consideration must be taken, such that the sensor and cable can be removed for service purposes. Filling pipes or tubes is **not** recommended unless strictly necessary.

Weitergabe sowie vervielfältigung dieser unterlage, verwertung und mitteilung ihres inhaltes nicht gestattet, soweit nicht ausdrücklich zugestanden. Zuwiderhandlungen verpflichten zu schadenersatz.

Toute communication ou reproduction de ce document, toute exploitation ou communication de ou son contenu sont interdites, sauf autorisation expresse. Tout manquement à cette règle est illicite et expose son auteur au versement de dommages et intérêts.

Copying of this document, and giving it to others and the use or communication of contents thereof, are forbidden without express authority. Offenders are liable to the payment of damages.

Sin nuestra expresa autorización, queda terminantemente prohibida la reproducción total o parcial de este documento, así como su uso indebido y/o su exhibición o comunicación a terceros. De los infractores Se exigirá el correspondiente resarcimiento de daños y perjuicios.

Contents

TERMINOLOGY	6
Units.....	6
Abbreviations.....	6
1. INTRODUCTION	7
System Overview.....	7
Sensor (Transducer)	8
Transceiver unit	8
Interfacing.....	9
Outputs.....	9
Inputs.....	9
Alarms.....	9
Operator Unit	9
2. OPERATION	10
Screen Select.....	10
Parameter entry	11
Primary Screens	11
Screen pilot, Menu 1, trip reset.....	12
Screen pilot, Menu 2, system.....	13
Screen shallow water, (only in non docking version).....	14
Screen docking, arrow view (only in docking version).....	15
Screen docking, bar graph view (only in docking version).....	16
Screen open sea, system.....	17
Setup and Function Control Screens.....	18
Enabling advanced parameters with Hidden button	19
Screen com, Menu 1, NMEA setup.....	20
Screen com, Menu 2, NMEA com setup.....	21
Screen status, Menu 1, units.....	23
Screen status, Menu 2, date/time.....	24
Screen status, Menu 3, boat setup/buzzer.....	24
Docking option parameter setup	24
Screen status, Menu 4, pulse settings.....	25
Screen status, Menu 5, analogue settings.....	25
Screen status, Menu 6, speed limits and hysteresis.....	26
Screen status, Menu 7, signal good/signal suspected.....	26
Screen status, Menu 8, speed test/simulate.....	26
Screen calibration, Menu 1, Auto calibration.....	27
Screen calibration, Menu 2, Manual calibration.....	28
Screen calibration, Menu 3, mounting settings.....	29
Screen calibration, Menu 4, mounting settings.....	29
Screen diagnostics, Menu 1, Details Off.....	30
Screen diagnostics, Menu 1, Details On.....	31
Screen diagnostics, Menu 2, filtering/averaging.....	32
Screen diagnostics, Menu 3, BT settings.....	32
Principal Functions	33
Doppler Log Principle.....	33
Bottom Track Characteristics.....	33
Water Track Characteristics	33
Non-volatile Parameter Memory.....	33
3. USER MAINTENANCE	35

Transducer Maintenance35

4. INSTALLATION.....36

Handling warning.....36

 Location.....37

Operator Unit Installation37

 115/230 V selection on Combo Terminal board inside Display Unit.....37

 AC Voltage selection.....38

 Fuses.....38

 Back-up Battery Jumper JP200.....39

 Power indication and function LEDs40

 Operator unit External connections.....42

 Operator unit - Terminal PCBconnections43

 Examples of optocoupler I/O connections44

 Alert relay connections45

 Power failure relay45

 Log Pulse Outputs.....46

 Speed Limit function.....46

 Inputs.....47

 Analogue interfaces.....47

 NMEA interface47

 Options47

 Repeaters/Slaves47

5. CALIBRATION PROCEDURE51

 Calibration routine:52

 Enabling of calibration52

 Step 1. Heading error correction:53

 Step 2a. Manual speed calibration/adjustment:.....53

 Step 2b. Semi Automatic calibration:54

6. TROUBLE SHOOTING56

Basic System Integrity56

Installation problems.....57

Interface problems58

Basic functionality58

Typical Status Screen Contents.....59

Screen diagnostics.....61

 Diagnostics.....62

 Recording of sensor data:.....65

Reset factory procedure.66

Master reset procedure.....66

7. SPECIFICATIONS67

Dimensions67

Functional Properties67

Environmental.....68

8. SERVICE69

10. APPENDIX 170

Miscellaneous Installation Diagrams70

 PCB positions in Transceiver Unit.....71

LEDs on PCBs in Transceiver Unit	72
DL 850 System Overview	73
Operator Unit - Transceiver Unit Interconnection	74
270 kHz Sensor Cable Connection	75
Ferrite on AC power input.....	76
Transceiver Unit Dimensions.....	77
Dimensional Drawing Cabinet.....	78
115/230 V selection on backplane inside Transceiver Unit	79
11. APPENDIX 2	80
Upgrading Software	80
CPU PCA-6742VE setup	81
12. APPENDIX 3. NON WHEELMARK APPROVED FEATURES	82
Echo sounder function.....	82
GPS:BT	83
13. APPENDIX 4. NON WHEELMARK APPROVED S VERSION	84
S-version of operator unit.....	84
14. APPENDIX 5. EXPERIMENTAL FEATURES.....	85
NMEA-Raw	85
Current function	86
Beam filter.....	87
Higher accuracy of depth and speed calculation.....	88
NAUT rules.....	89
15. INDEX.....	90

Terminology

Units

Unless otherwise stated, all values shown on the display are as follows:

Distance	Nautical miles (nm)
Speed	Nautical miles per hour (kn)
Rotation	°/min (Degrees per minute)
Pulse indication	Pulses per nautical mile (p/nm)
Temperature	Degrees Celsius (°C)

Abbreviations

In addition, the following symbols are used on the runtime screens:

°	Degrees centigrade
STW	Speed through water
TRIP	Text for trip/total
SOG	Speed over ground
TEMP °	Text for TEMPerature

In menu / setup screens, the following abbreviations are used:

WT	Water track for speed through water.
BT	Bottom track for speed over ground
Sim	Simulation of speed.
SPD LIMIT ▲ / SPD LIMIT ▼	Speed limit high/low for output to external equipment
LONG	Longitudal speed. (Forward/aft direction)
TRANSV	Transversal speed (Port/Starboard direction)
PULSE	Pulse settings
OFS °	Angular offset in degrees (°)
R	Real resultant speed at a specific point (kn)
M	Measured resultant speed at a specific point (kn)

1. Introduction

System Overview

The system is a navigation, 2 axis (transversal and longitudinal) Doppler speed log with a large LCD. The display graphics is continuously shown on the LCD along with available navigation details. Comprehensive interfaces are available including IEC 61162-1:2007(E) (NMEA 0183) input and output. All IMO (International Maritime Organization) requirements for speed logs are met or exceeded.

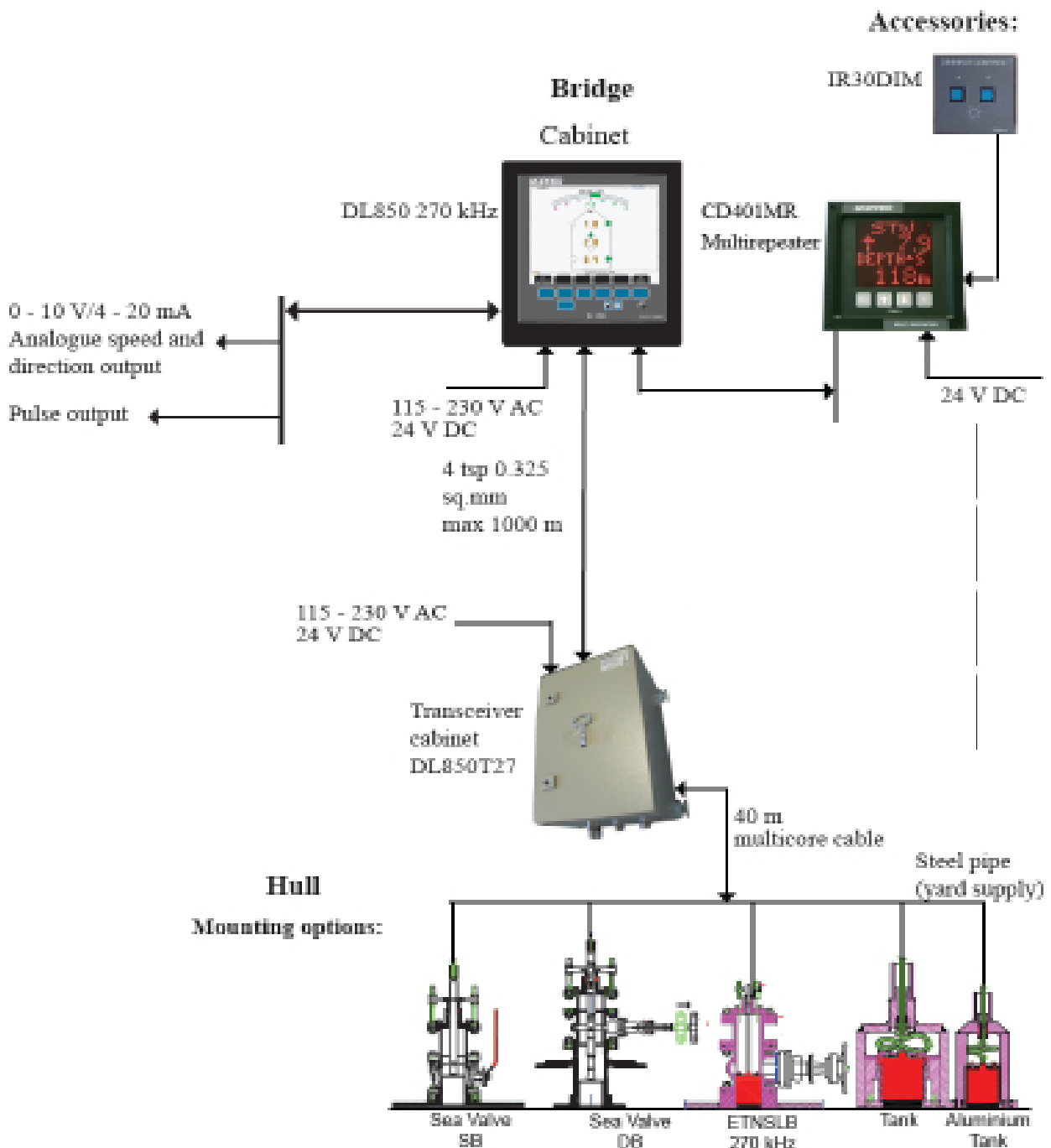

Sensor (Transducer)

The Doppler sensor consists of a head with 3 hydro-acoustic elements. The elements are transmitting/receiving acoustic signals at 270kHz. Out of the received doppler shifted frequencies it is possible to calculate the speed in 2 axis. The sensor is connected to a transceiver cabinet located within 40 m of the sensor.

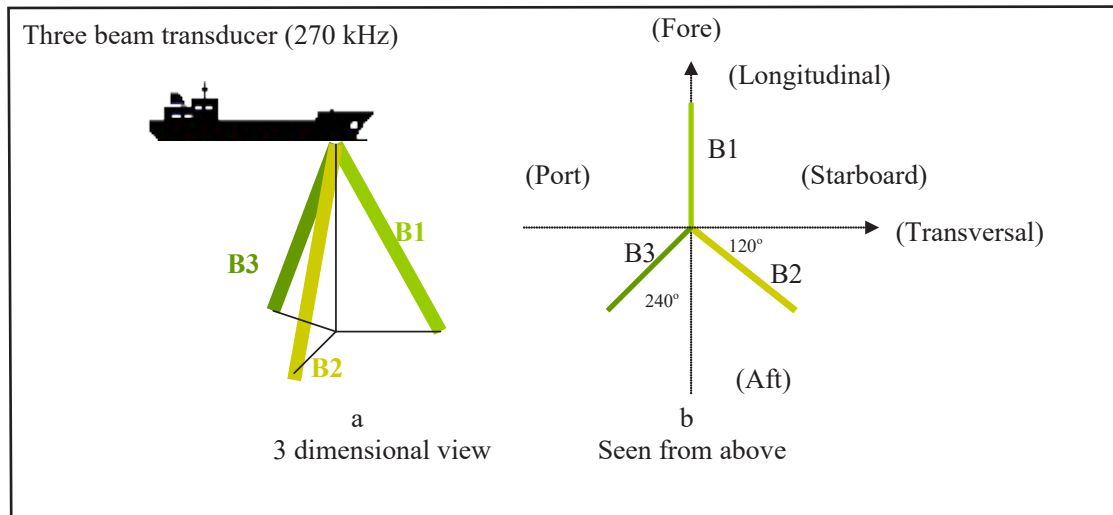

Transceiver unit

The connection from the transceiver cabinet to the operator unit is via a serial RS-422 data link and may be up to 1000 m. Transceiver and operator unit power supply options are 115/230 V AC or 24 V DC. The power consumption for the transceiver unit is app. 80 Watt at 115/230 V AC or 60 Watt at 24 V DC.



Operator Unit

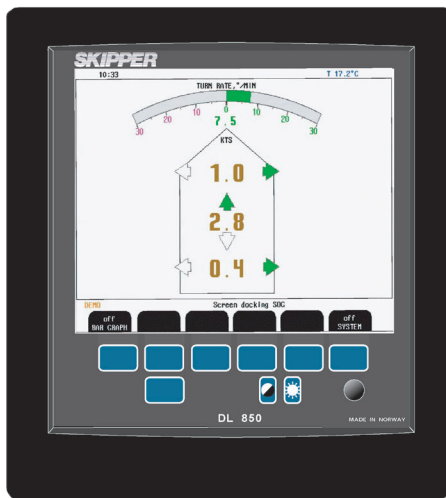

The operator unit contains a graphic LCD display and a keyboard with fixed keys, softkeys and a rotating encoder.

The function of each softkey button depends on the active screen, and the buttons are labelled on the lower rim of the LCD.

The display is back lit, and back light intensity may be adjusted by the user. Various user-selectable information layouts adapted to typical operational situations, may be displayed continuously on the LCD. The operator unit can be flush mounted, wall mounted or bracket mounted.

Operator unit power supply options are 115/230 V AC or 24 V DC. The power consumption is app. 70 Watt at 115/230 V AC or 50 Watt at 24 V DC.

Interfacing

The display unit has various interface possibilities.

Outputs

- 3 log pulse outputs 10/100/200/400/1000 pulses per nautical mile, see [“Log Pulse Outputs” on page 46.](#)
- 2 outputs also gives speed direction, see [“Log Pulse Outputs” on page 46.](#)
- 3 analogue outputs 0 - 10 V or 4 - 20 mA, see [“Analogue interfaces” on page 47.](#)
- IEC 61162-1:2007(E) (NMEA 0183) interface output of speed/distance, temperature and depth information, see [“Softkey” on page 89.](#)
- Power failure alert, see [“Power failure relay” on page 45.](#)
- Speed limit, see [“Speed Limit function” on page 46.](#)
- External VGA monitor, see [“External Interface Ports” on page <?>.](#)

Inputs

- IEC 61162-1:2007(E) (NMEA 0183) interface input for position, rate of turn, heading and UTC (Coordinated Universal Time), see [“Softkey” on page 89](#)

Alerts

A power failure alert is provided on a potential free relay contact. This may be used for interface to external alert systems.

2. Operation

When the installation is complete, and power is connected to the operator unit, the system is switched on/off by a power switch inside the cabinet.

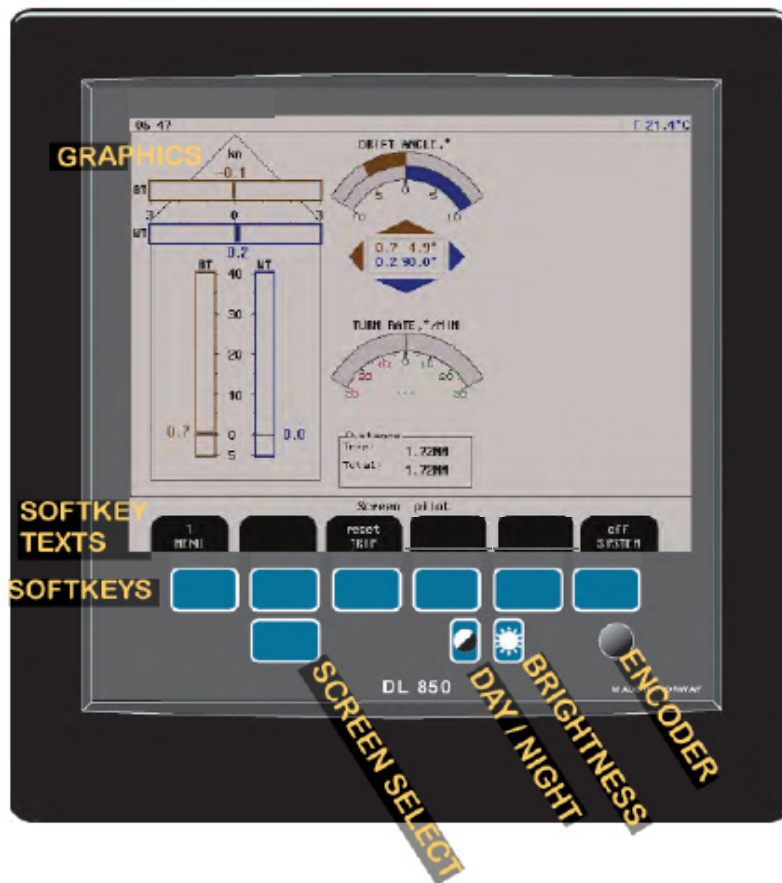

Fig. 1.1 Operator unit, panel layout.

Screen Select

The screen select button facilitates selection of one of the 7 screen and softkey layouts. The 3 primary operation screens (Screen Pilot, Screen Docking/Shallow Water and Screen Open Sea) may be cycled by repeatedly pressing the SCREEN SELECT button. Access to the remaining 4 screens (Screen Com, Screen Status, Screen Calibration and Screen Diagnostic) is done by pressing the “Screen select” and at the same time turn the “encoder”.

Day/Night

Day/Night vision may be selected by pressing this button. These two modes differs by colour presentation, which are optimized for different ambient light conditions.

Brightness

Backlight may be controlled by using the appropriate button and the encoder. Press the backlight button and rotate the encoder until a satisfactory setting is obtained, then release the button. The settings are maintained in the memory, and the last settings are restored on power up.

Parameter entry

The fixed function buttons and the softkey buttons along with the rotating encoder, facilitates entry of parameters and other data. The following flowchart illustrates the procedure for changing settings. The various screens are shown in detail in the operation section.

Primary Screens

Each of the operation screens contains a graphic picture and one or more menu sets configured on the 6 softkey buttons. The three first screens are covering the primary functions. Manoeuvring within these screens are easily done by pressing the SCREEN SELECT button.

The various screens can also be selected by keeping the SCREEN SELECT button pressed and rotating the encoder in either direction. Turning the encoder clockwise cycle the screens as shown in figure below, and counter clockwise rotation cycles the screens in the opposite direction.

The screen layouts are outlined in the following pages. The various menus and softkey functions are described with each screen.

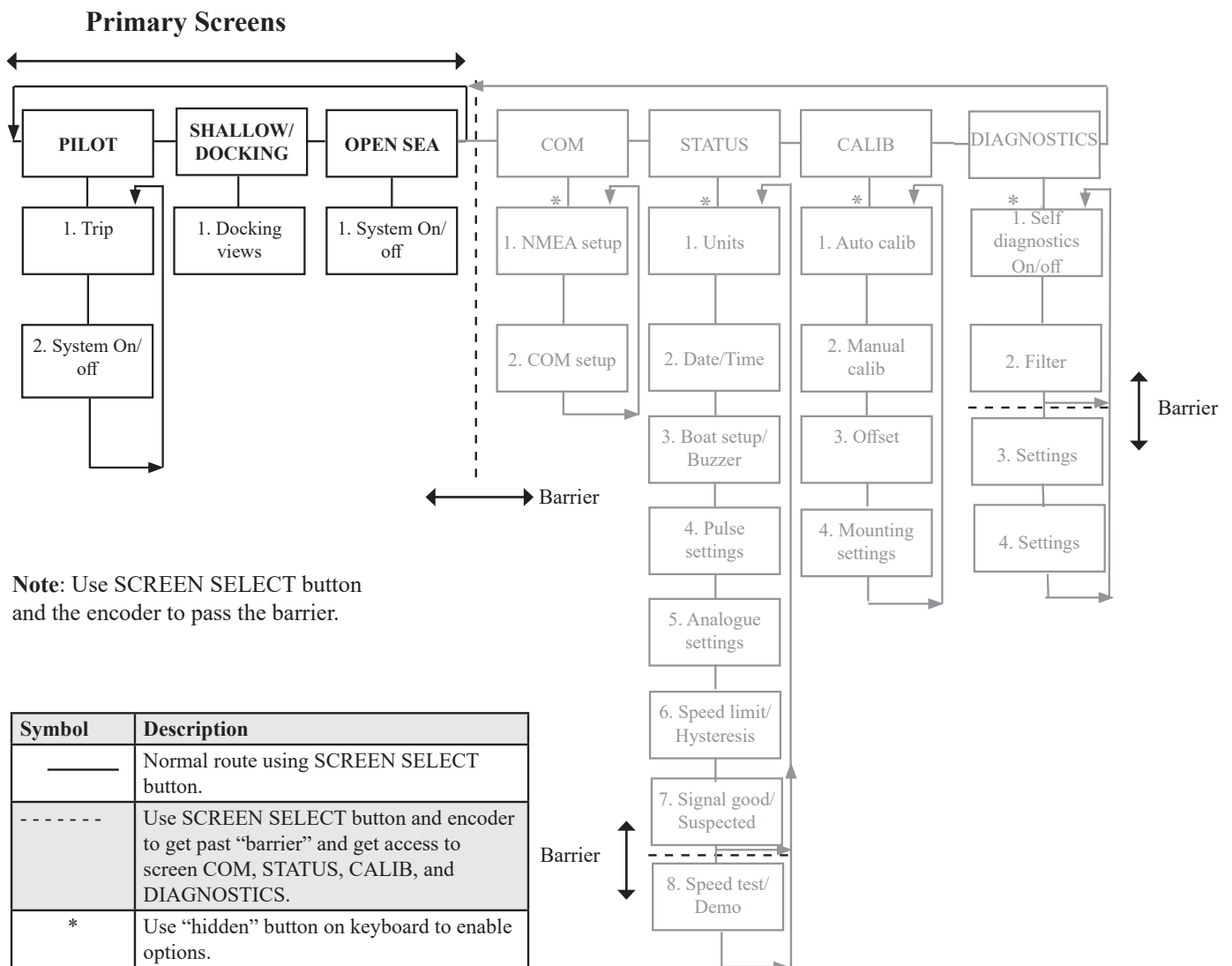

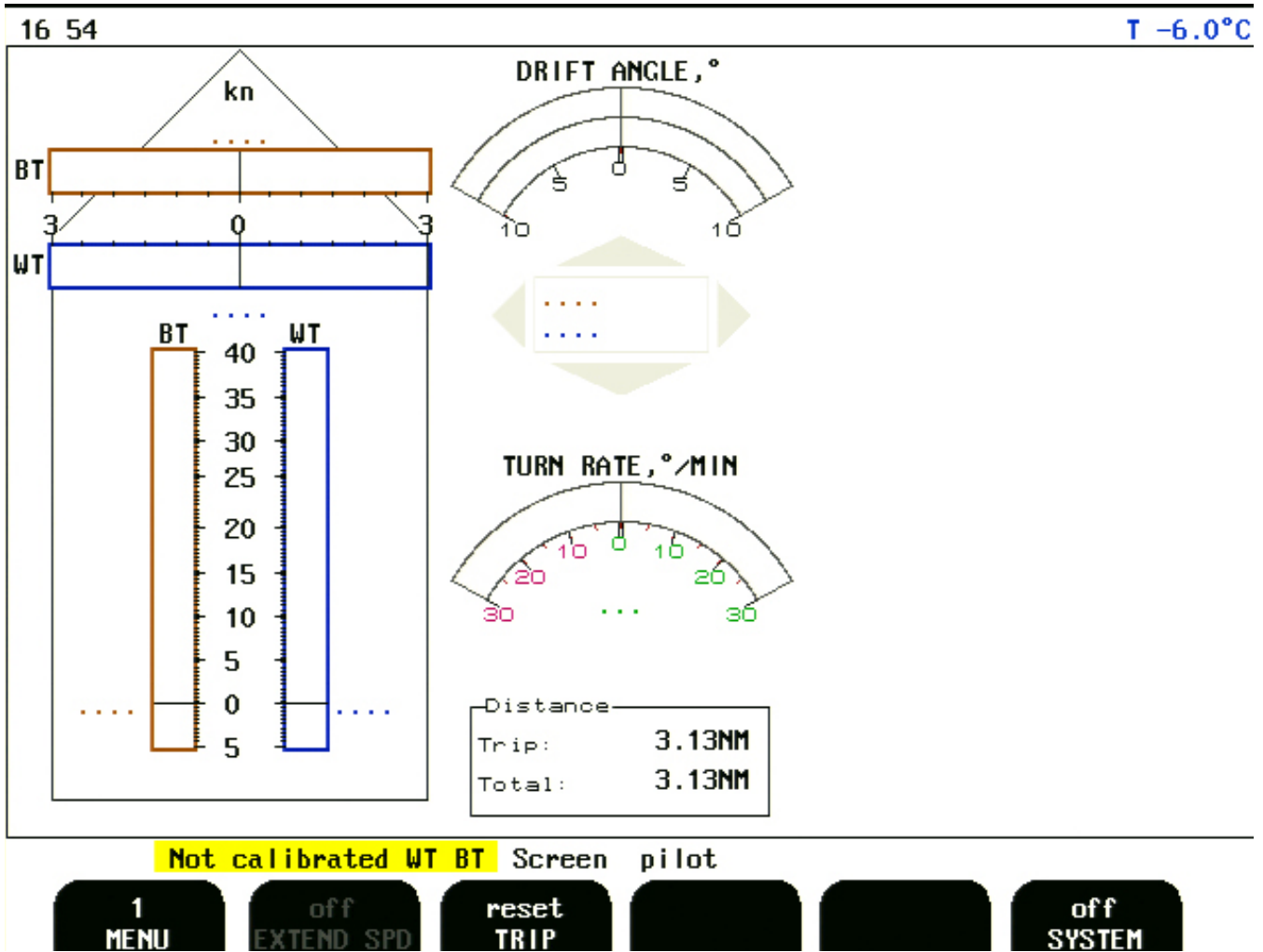

The various softkey menus are selected by pressing repeatedly the MENU button on the left side of the softkey menu. The number on the button indicates present active menu.

- “Brown” (BT) is speed over ground.
- “Blue” (WT) is speed through water.
- Drift angle is the angle between the longitudinal axis and resultant speed vector.

Screen pilot, Menu 1, trip reset.

Softkey	Name	Range/value	Default value	Description	Activate with hidden button
1	MENU	1 - 2	1	Menu 1 is selected.	
2	EXTENDED SPEED	Speed range maximum 40 or 60 knot	40	Extends maximum speed range to 60 knots. (Only in Docking version.)	Yes (2 beeps)
3	TRIP	Reset		Trip distance counter reset.	
4					
5					
6	SYSTEM	On/Off	On	Turn system off.	

Note: The message “Not calibrated WT BT” will appear as long as no speed calibration is performed.

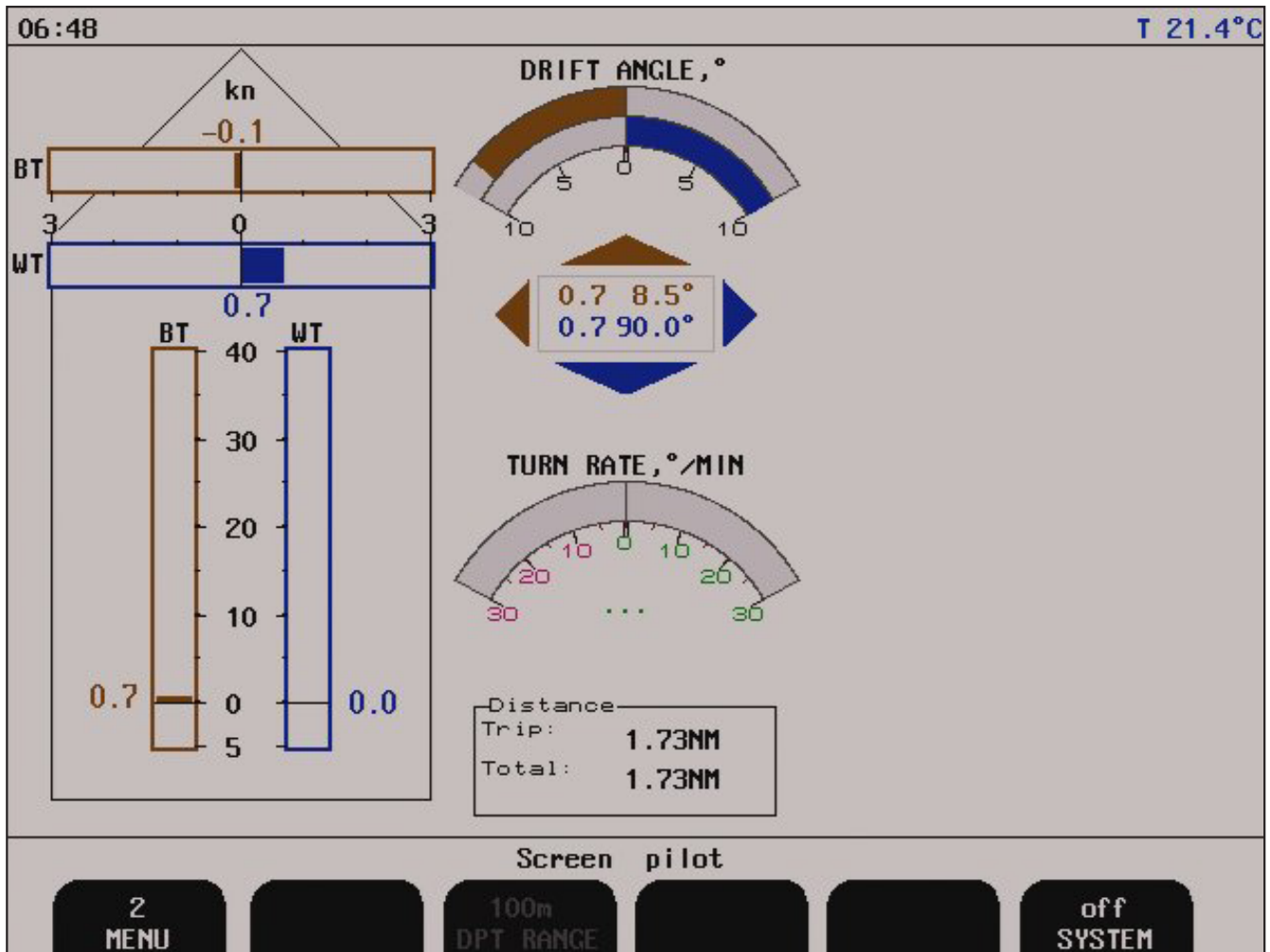

The various softkey menus are selected by pressing repeatedly the MENU button on the left side of the softkey menu. The number on the button indicates present active menu.

Screen pilot, Menu 2, system.

Softkey	Name	Range/value	Default value	Description	Activate with hidden button
1	MENU	1 - 2	2	Menu 2 is selected.	
2				Not used.	
3				Normally not used.	(See “12. Appendix 3. Non wheelmark approved features” on page 82).
4				Not used.	
5				Not used.	
6	SYSTEM	On/Off	On	Turn system off.	

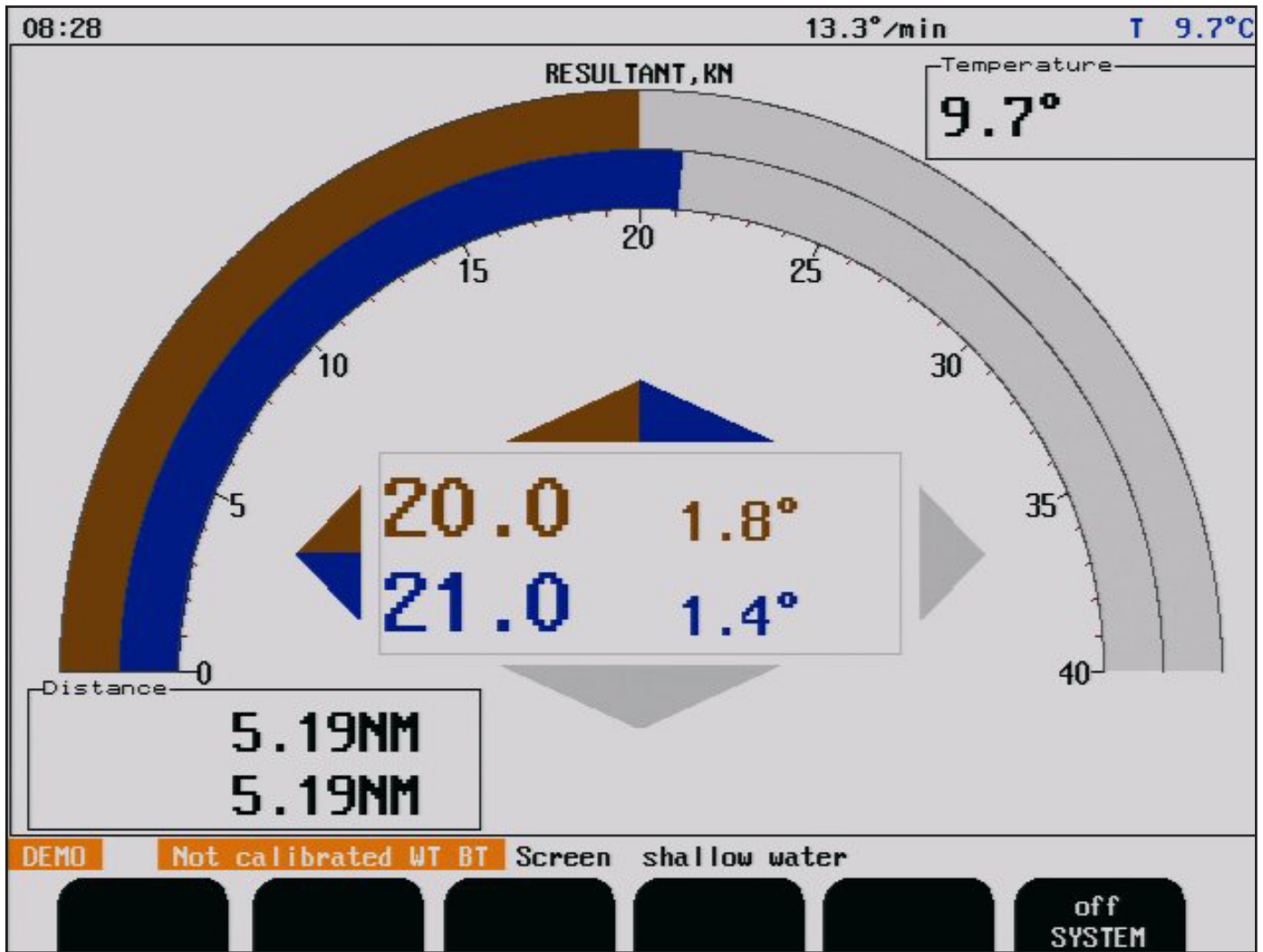

- Screen description “blue” shows resultant water speed and direction.
- Screen description “brown” shows resultant SOG (speed over ground) and direction. (Note: Value should be close to GPS value).
- Temperature is temperature in water.

Screen shallow water, (only in non docking version).

Softkey	Name	Range/value	Default value	Description	Activate with hidden button
1				Not used.	
2				Not used.	
3				Not used.	
4				Not used.	
5				Not used.	
6	SYSTEM	On/Off	On	Turn system off.	

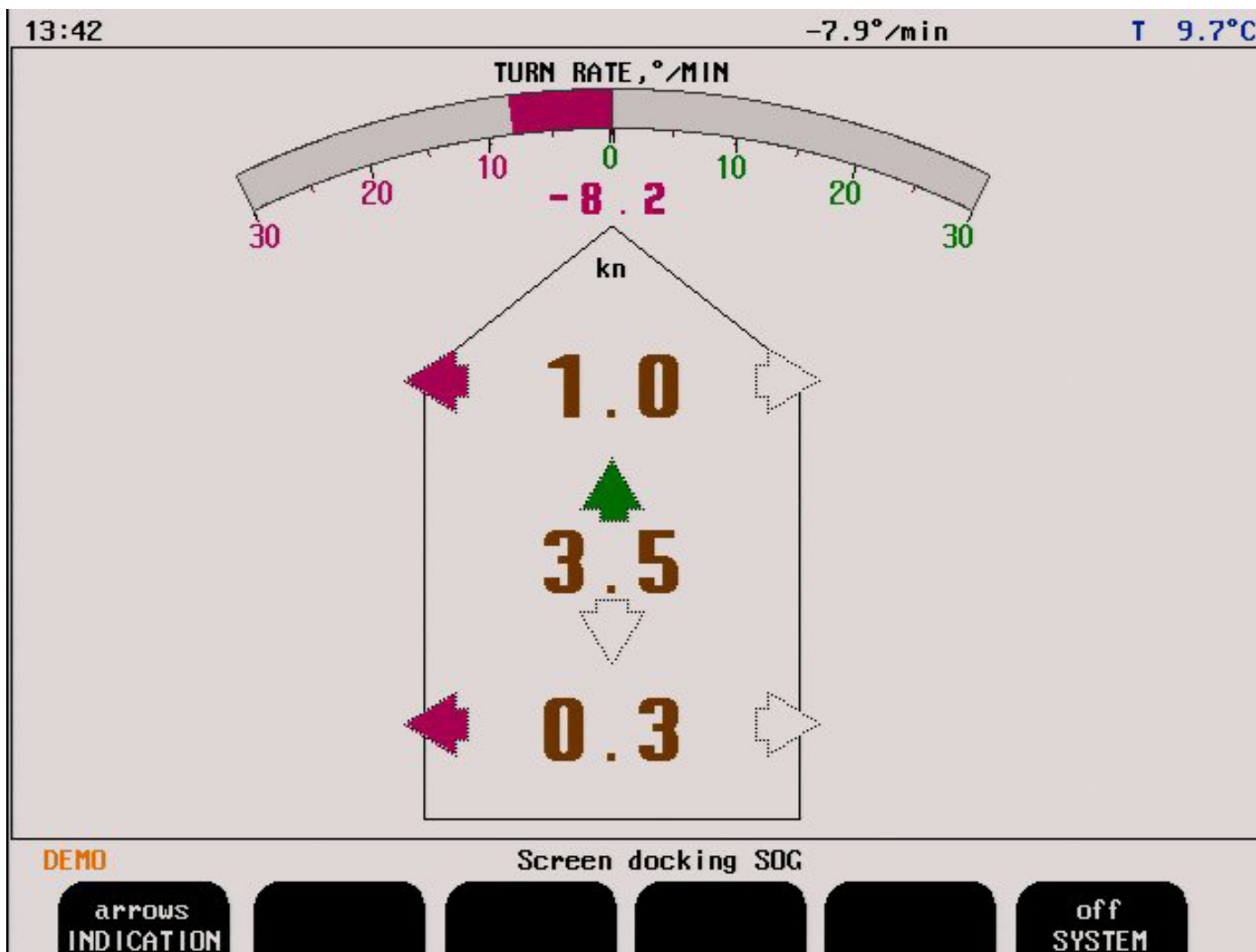

If bottom track is present, the docking screen will show measured longitudinal and transversal speed over ground (SOG) at fore and calculated speed at stern point. Speed indication may either be presented by values and arrows, or values and bars for directions.

Screen docking, arrow view (only in docking version).

Softkey	Name	Range/value	Default value	Description	Activate with hidden button
1	INDICATION	Arrows/bar graphs	Arrows	Arrow indication is selected.	
2				Not used.	
3				Not used.	
4				Not used.	
5				Not used.	
6	SYSTEM	On/Off	On	Turn system off.	

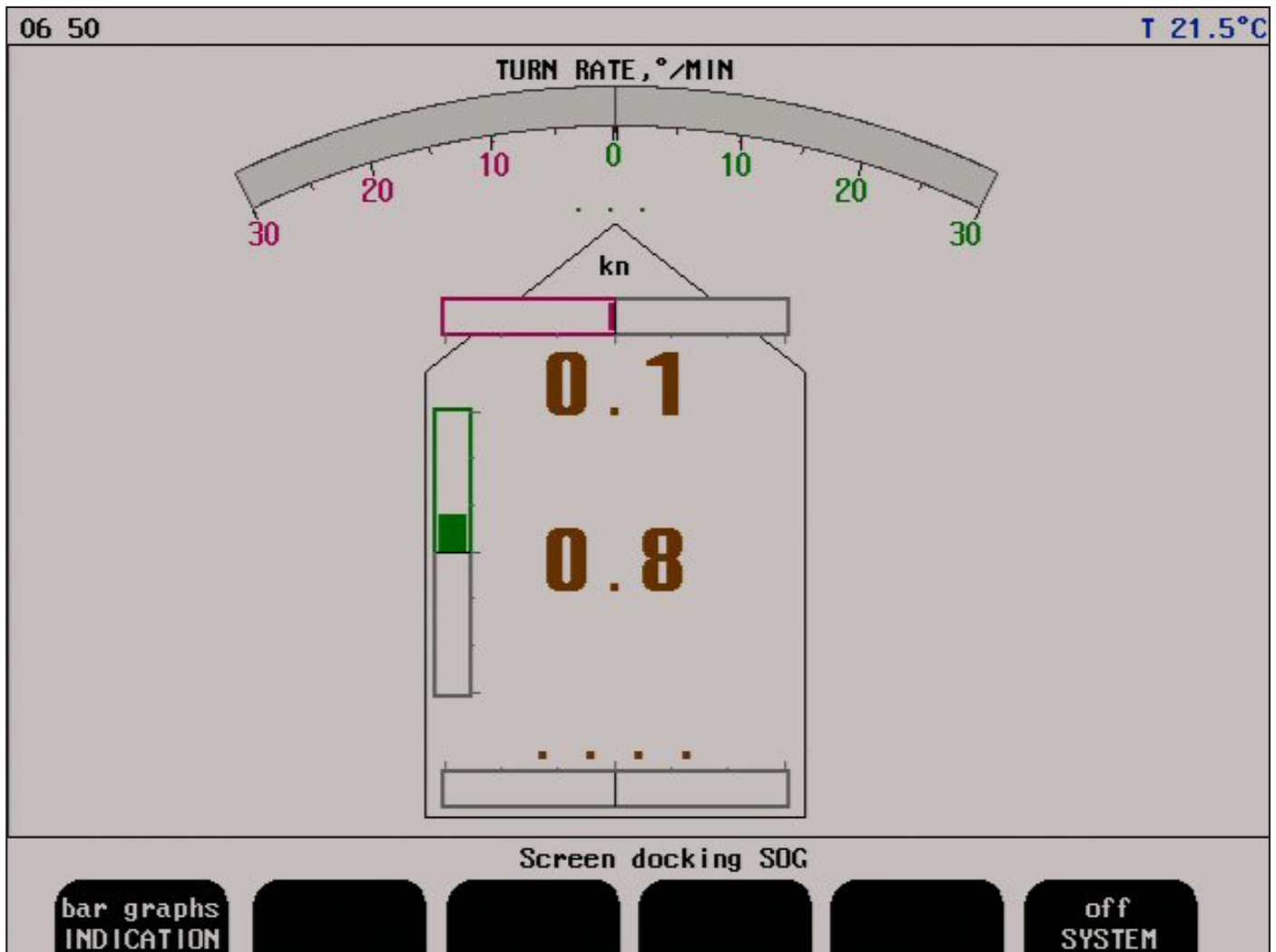

The screen above shows the result if ROT (Rate Of Turn) information is not available.

Screen docking, bar graph view (only in docking version).

Sofkey	Name	Range/value	Default value	Description	Activate with hidden button
1	INDICATION	Arrows/bar graphs	Bar graphs	Bar graph indication is selected.	
2				Not used.	
3				Not used.	
4				Not used.	
5				Not used.	
6	SYSTEM	On/Off	On	Turn system off.	



Screen open sea, system.

Softkey	Name	Range/value	Default value	Description	Activate with hidden button
1				Not used.	
2				Not used.	
3				Not used.	
4				Not used.	
5				Not used.	
6	SYSTEM	On/Off	On	Turn system off.	

Note: This screen shows speed through water only. for use when vessel is in deep open sea.

Setup and Function Control Screens

Each of the operation screens contains a graphic picture and one or more menu sets configured on the 6 softkey buttons. Manoeuvre to the setup and function control screens by keeping the screen select button pressed and rotating the encoder in either direction. Turning the encoder clockwise cycle the screens as shown in figure below, and counter clockwise rotation cycles the screens in the opposite direction.

The screen layouts are outlined in the following pages. The various menus and softkey functions are described with each screen.

Setup and Function Control Screens

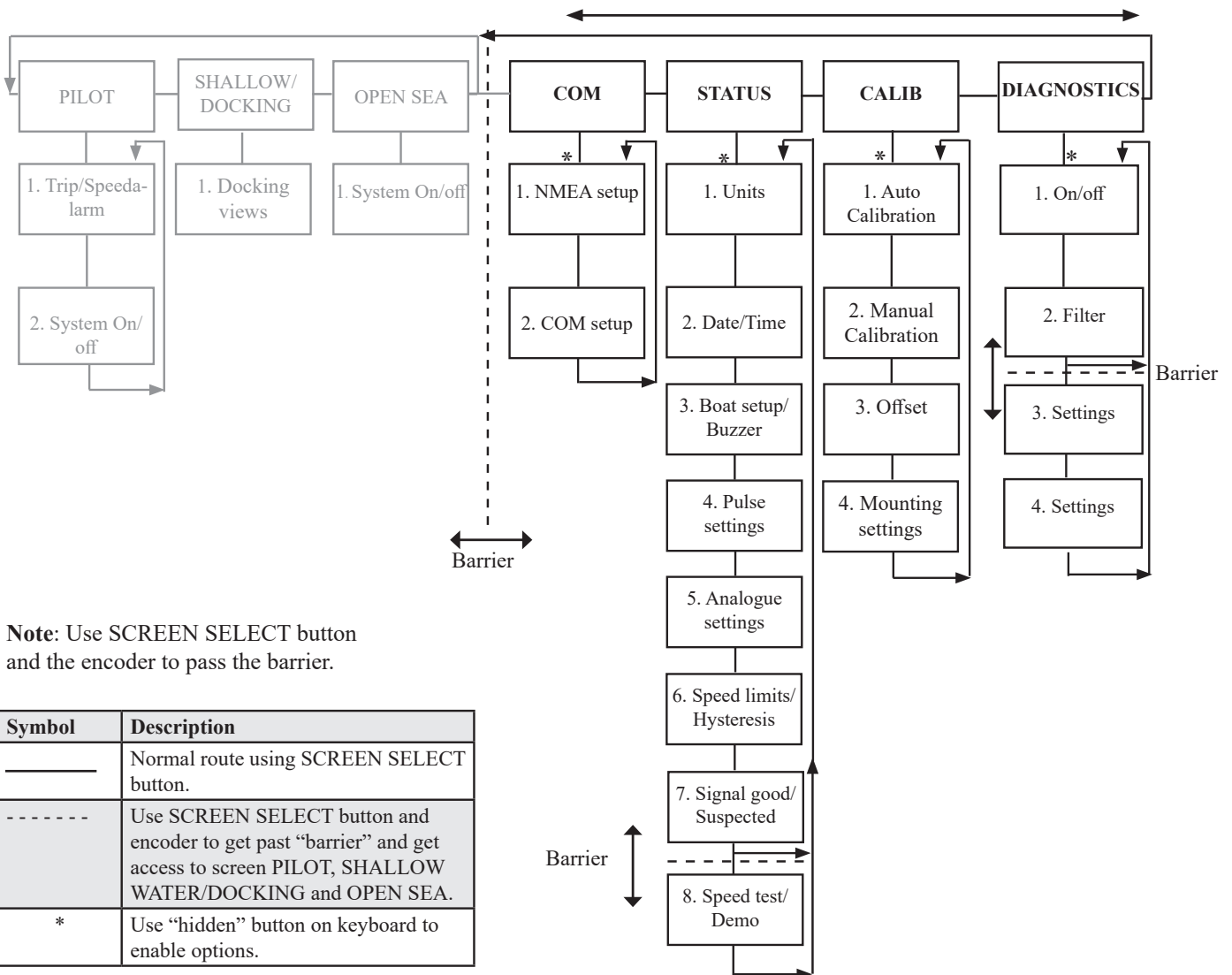

Enabling advanced parameters with Hidden button

To avoid accidental access to the internal settings, some advanced functions are disabled during normal operation. In order to enable them, do the following:

- Open front door of the cabinet and find a “hidden” key on the component side of the keyboard PCB (upper/left corner of the PCB).
- Press key mentioned above and keep it pressed for 2 seconds, until you hear 1 beep.
- The text on the advanced function soft keys will change colour from grey to white, which indicates availability of the corresponding functions.
-
- There are 2 levels of advanced functions. Function enabled by 2 beeps (4 seconds) may interfere the speed log performance and should normally not be changed.
- To reset all settings to default, See [”RESET FACTORY” on page 26](#)

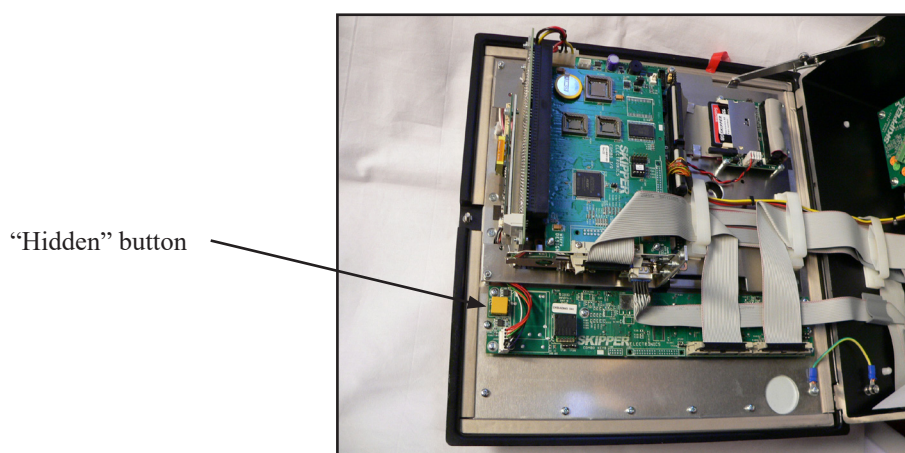

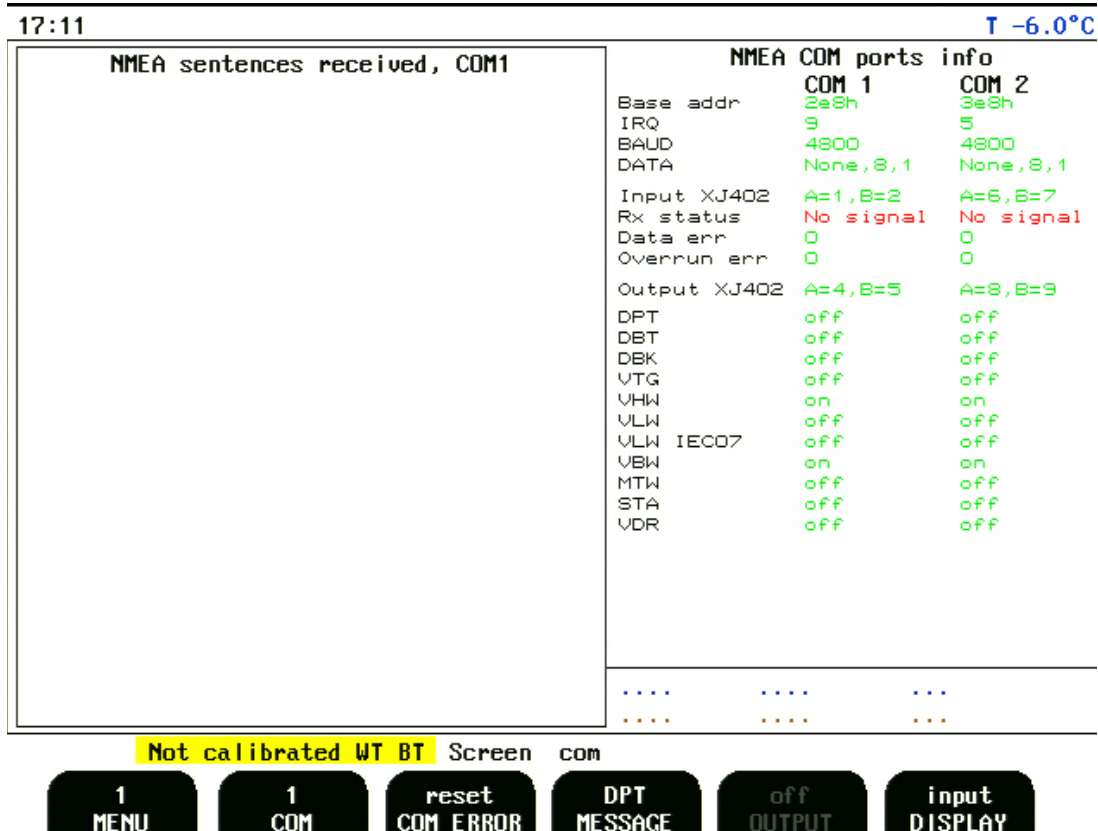

Note: The displayed messages corresponds to currently selected port.

Screen com, Menu 1, NMEA setup.

Softkey	Name	Range/value	Default value	Description	Activate with hidden button
1	MENU	1-2	1	Menu 1 is selected.	
2	COM	1-2	1	Select COM port. The ports can be configured to give different messages on the different ports.	
3	RESET COM ERROR	Reset		Reset of Data error counter. The program memorizes the latest occurred NMEA input error for further analysis. By using this softkey, it is possible to reset the error.	
4	MESSAGE	DPT, DBT, DBK, VTG, VHW, VLW, VLW IEC07, VBW, MTW, STA, VDR		NMEA message selector. Each message may be controlled individually by softkey 5. (Note: See "" on page 48).	
5	OUTPUT	On/Off	See fig above.	Setting for the message in softkey 4. Note: To configure the serial output of the system, go through all the messages by pressing softkey 4 and set on/off value with softkey 5 to disable/enable a message as required.	Yes (1 beep)
6	DISPLAY	Output/input/off	Input	Selects the information (received from the external source or transmitted by the DL850) to be displayed on the screen. Output: Signals transmitted from DL850. Input: Signals received from external source. Off: No signals displayed on screen.	

17:14 T -6.0°C

NMEA sentences received, COM1

NMEA COM ports info

	COM 1	COM 2
Base addr	2e8h	3e8h
IRQ	9	5
BAUD	4800	4800
DATA	None,8,1	None,8,1
Input XJ402	A=1,B=2	A=6,B=7
Rx status	No signal	No signal
Data err	0	0
Overrun err	0	0
Output XJ402	A=4,B=5	A=8,B=9
DPT	off	off
DBT	off	off
DBK	off	off
VTG	off	off
VHW	on	on
VLW	off	off
VLW IEC07	off	off
VBW	on	on
MTW	off	off
STA	off	off
VDR	off	off

Not calibrated WT BT Screen com

2 MENU	1 COM	4800 BAUD	None,8,1 DATA		
-----------	----------	--------------	------------------	--	--

Screen com, Menu 2, NMEA com setup.

Softkey	Name	Range/value	Default value	Description	Activate with hidden button
1	MENU	1-2	2	Menu 2 is selected.	
2	COM	1-2	1	Choose COM port.	
3	BAUD	1200, 2400, 4800, 9600, 19200, 38400, 57600, 115200	4800	Baud rate for chosen COM port.	Yes (1 beep)
4	DATA	None-7-1, Even-7-1, Odd-7-1 None-7-2, Even-7-2, Odd-7-2 None-8-1, Even-8-1, Odd-8-1 None-8-2, Even-8-2, Odd-8-2	None, 8, 1	Data format for chosen COM port. Parity, data bits, stop bits.	Yes (1 beep)
5					
6					

Note: Baud rate and data settings apply to both input and output for selected COM port. Not recommended to use BAUD values above 38400 on terminals boards earlier than version E.

14 37
T 22.2°C

NMEA sentences received, COM1	NMEA COM ports info	
<pre> \$WIMWD,93.2,T,92.8,M,12.3,N,,*02F0 \$HEHDT,123.40,T*1BF0 \$HEHDT,123.40,T*FF0 \$HEHDT,123.40,T0 \$TIHDT,123.40,T*0BF0 \$SHEROT,10.40,A*2E0 \$SHEROT,10.40,V*390 \$WIMWD,93.2,T,92.8,M,12.3,N,,*02F0 \$WIMWD,93.2,T,92.8,M,12.3,N,,*02F0 \$HEHDT,123.40,T*1BF0 \$HEHDT,123.40,T*FF0 \$HEHDT,123.40,T0 \$TIHDT,123.40,T*0BF0 \$SHEROT,10.40,A*2E0 \$SHEROT,10.40,V*390 \$WIMWD,93.2,T,92.8,M,12.3,N,,*02F0 \$WIMWD,93.2,T,92.8,M,12.3,N,,*02F0 \$HEHDT,123.40,T*1BF0 \$HEHDT,123.40,T*FF0 \$HEHDT,123.40,T0 \$TIHDT,123.40,T*0BF0 \$SHEROT,10.40,A*2E0 </pre>	COM 1	COM 2
Base addr	2e8h	3e8h
IRQ	9	5
BAUD	4800	4800
DATA	None,8,1	None,8,1
Input XJ402	A=1,B=2	A=6,B=7
Rx status	0'k	No signal
Data err	0	0
Overrun err	0	0
Output XJ402	A=4,B=5	A=8,B=9
DPT	off	off
DBT	off	off
DBK	off	off
VTG	off	off
VHW	on	on
VLW	off	off
VLW IEC07	off	off
VBW	on	on
MTW	off	off
STA	off	off
VDR	off	off
	0.2kn	0.1kn
	0.2kn	0.1kn
		19.5°
		14.5°

DEMO
Screen com

1
MENU

1
COM

DPT
MESSAGE

off
OUTPUT

input
DISPLAY

The following examples show how the system responds to errors in the NMEA input formats. Formats in yellow are rejected. See “NMEA Setup” on page 48 for more informations about accepted formats.

Input NMEA message	Description	Format status
\$TIHDT,123.40,T*1B	Correct, accepted format with checksum.	Accepted.
\$SHEROT,10.40,A*2E	Correct, accepted format with checksum.	Accepted.
\$SHEROT,10.40,V*39	Correct, accepted format with checksum but invalid status symbol.	Rejected.
\$HEHDT,123.4,T	Correct, accepted format without checksum.	Rejected.
\$HEHDT,123.4,T*FF	Correct, accepted format with wrong checksum.	Rejected.
\$WIMWD,93.2,T,92.8,M,12.3,N,,*02	Correct, not recognised format.	Rejected.

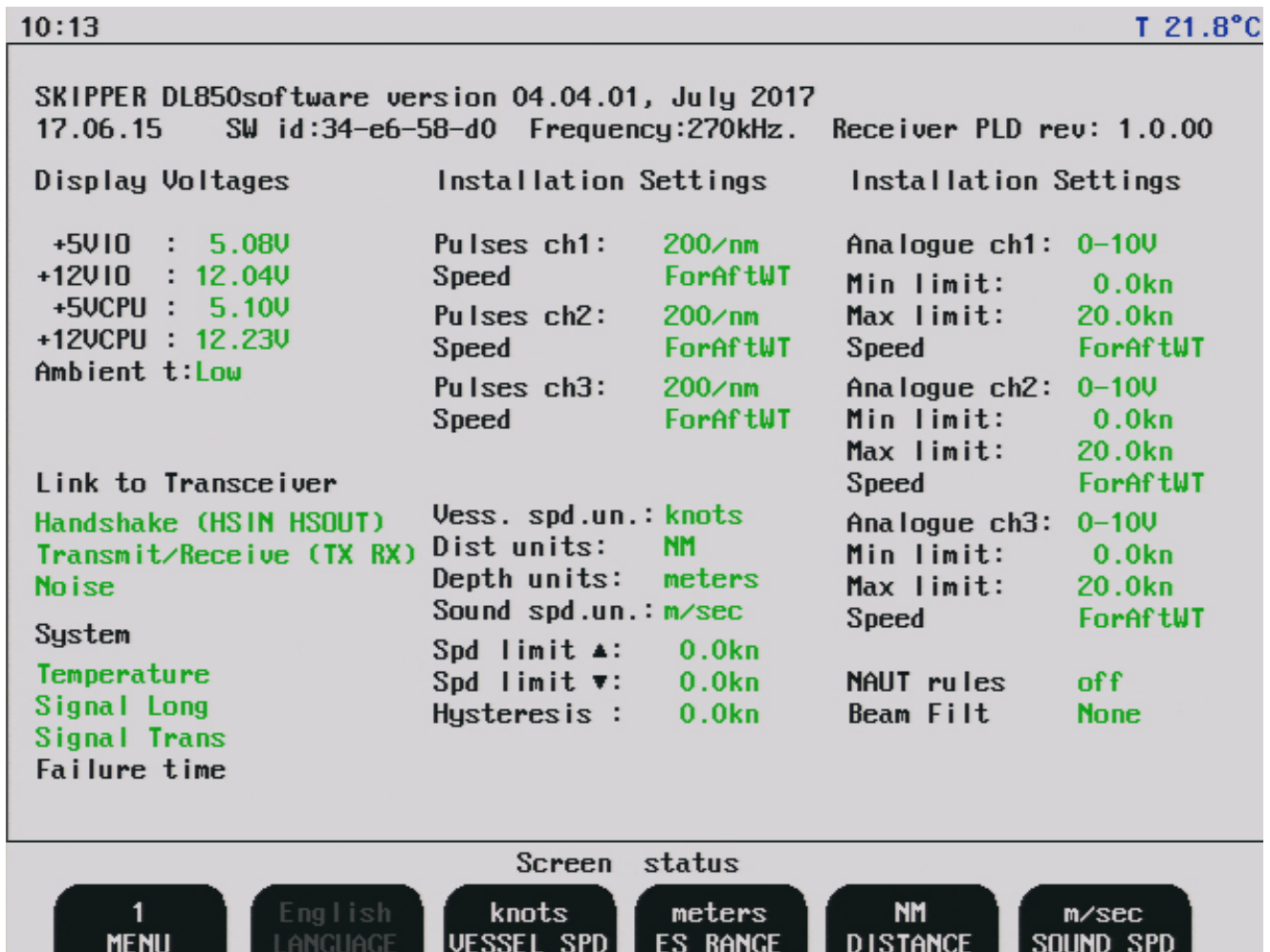

The status screen contains information that will facilitate analysis and correction of several problems. All installation settings are displayed on this screen. See section for trouble-shooting for more information about typical status screen content.

Screen status, Menu 1, units.

Softkey	Name	Value/range	Default value	Description	Activate with hidden button
1	MENU	1 - 8	1	Menu 1 is selected.	
2	LANGUAGE	English		Not active.	
3	VESSEL SPD	knots, km/h, mi/h, m/sec	knots	Select speed unit.	
4	ES RANGE	meters, feet, fathoms, braccias	meters	Select depth unit.	
5	DISTANCE	NM, km, mi	NM	Select distance unit.	
6	SOUND SPD	m/sec, ft/sec, knots, km/h, mi/h	m/sec	Select sound speed unit.	

Note: See [“System Adaption” on page 22](#) for more information.

System:

Text in red indicates a possible problem with the system, text in orange indicates a potential but non critical problem. In both cases, run self diagnostics in the diagnostic screen to find the source of the problem. **Note:** More about the status information in section [“Typical Status Screen Contents” on page 59](#).



Screen status, Menu 2, date/time.

Softkey	Name	Range/value	Default value	Description	Activate with hidden button
1	MENU	1 - 8	2	Menu 2 is selected.	
2				Not used.	
3	YR.MONTH	00.01 - 31.12		Year and month setting.	
4	DAY	01 - 31		Day setting.	
5	HOURS	00 - 23		Hours setting.	
6	MINUTES	00 - 59		Minutes setting.	

Note: If time and date information are provided on the NMEA input, these will have highest priority and time and date softkeys are disabled (dimmed).



Screen status, Menu 3, boat setup/buzzer.

Softkey	Name	Value/range	Default value	Description	Active with hidden button
1	MENU	1 - 8	3	Menu 3 is selected.	
2	SHIP LEN	0.00 - 500.0 m	150.0 m	Overall ship length (used for docking mode).	Yes (1 beep)
3	BOW<->SENS	0.00 - 500.0 m	5.00 m	Distance from bow to sensor (used for docking mode).	Yes (1 beep)
4				Not used.	
5	DRAUGHT	0.00 - 99.9 m	0.00 m	Echo sounder draught.	Yes (1 beep)
6					

Docking option parameter setup

Two parameters must be set to ensure that the docking option is showing the correct stern speed.

- **Sensor to bow:** Total length from sensor location to the bow.
- **Ship length:** Total ship length, bow to stern.



Screen status, Menu 4, pulse settings.

Softkey	Name	Range/value	Default value	Description	Active with hidden button
1	MENU	1 - 8	4	Menu 4 is selected.	
2	OUT NUM	1 - 3	1	Pulse output channel to be configured by softkey 3 and 4 (Ch 1, Ch 2 and Ch 3). Note: If speed limit is activated, only OUT NUM 2 and 3 are available.	
3	PULSES NUM	10/100/200/400/1000/nm	200/nm	Number of pulses per nautical mile at selected channel (softkey 2). Note: 1000/nm only on Ch 3 (OUT NUM3).	Yes (1 beep)
4	OUT MODE	ForAftWT, LateralWT, ResultWT, ForAftBT, LateralBT, ResultBT.	ForAftWT	Type of speed value to be output at selected channel.	Yes (1 beep)
5				Not used.	
6				Not used.	



Screen status, Menu 5, analogue settings.

Softkey	Name	Range/value	Default value	Description	Activate with hidden button
1	MENU	1 - 8	5	Menu 5 is selected.	
2	OUT NUM	1 - 3	1	Analogue output channel to be configured by softkey 3 - 6 (Ch1, Ch 2, Ch 3).	
3	ANA MODE	0 - 10 V 4 - 20 mA	0 - 10 V	Select output mode for this channel (softkey 2).	Yes (1 beep)
4	OUT MODE	ForAftWT, LateralWT, ResultWT, ForAftBT, LateralBT, ResultBT.	ForAftWT	Type of speed value to be output at selected channel (softkey 2).	Yes (1 beep)
5	ANA MIN	-48.6 - 48.4 kn	0.0 kn	Speed value, corresponding to minimum analogue value at selected channel. Corresponds to 0 V, 4 mA.	Yes (1 beep)
6	ANA MAX	-48.4 - 48.6 kn	20.0 kn	Speed value, corresponding to maximum analogue value at selected channel. Corresponds to 10 V, 20 mA.	Yes (1 beep)



Screen status, Menu 6, speed limits and hysteresis

Softkey	Name	Range/value	Default value	Description	Activate with hidden button
1	MENU	1 -8	6		
2	SPD LIMIT▲	-48.6 - 48.6 kn	0.0 kn	High speed limit value.	Yes (1 beep)
3	SPD LIMIT▼	-48.6 - 48.6 kn	0.0 kn	Low speed limit value.	Yes (1 beep)
4	HYSTERESIS	0.0 - 2.0 kn	0.0 kn	Difference between high and low limit.	Yes (1 beep)
5	Not used			Not used	
6	Not used			Not used	

Screen status



Screen status, Menu 7, signal good/signal suspected

Softkey	Name	Range/ value	Default value	Description	Activate with hidden button
1	MENU	1 -8	7		
2	SIGN. GOOD	6- 90 %	50 %	Min. sample % to be qualified as good.	Yes (1 beep)
3	SIGN. SUSP(ECTED)	5 - 89 %	25 %	Min. sample % to be qualified as suspected.	Yes (1 beep)
4	Not used			Not used	
5	RESET FACTORY	Reset		Reset of log settings without reset of calibration I/O settings and trip. (Alternative to Master reset)	Yes (1 beep)
6	NAUT RULES	off/on	off	See appendic 5	Yes (3 beep)



Screen status



Screen status, Menu 8, speed test/simulate.

Functions described below can be used during commissioning period to test different DL850 outputs with constant, user adjustable speed values.

Note: When the test or simulator mode is activated, this will be indicated by flashing “Sim” label in the lower left part of the screen.

Note: Use the SCREEN SELECT softkey and the encoder to get access to screen status menu 8.

Softkey	Name	Range/value	Default value	Description	Activate with hidden button
1	MENU	1 -8	8	Note: Press MENU softkey and turn encoder to select menu 8.	
2	SPD TEST	On/Off	Off	Toggling test mode.	Yes (1 beep)
3	LONG. SP	-40.0 - 40.0 kn	0.0 kn	Select test value for longitudinal speed.	Yes (1 beep)
4	TRANSV. SP	-5.0 - 5.0 kn	0.0 kn	Select test value for transversal speed.	Yes (1 beep)
5	DISTANCE	Auto, 0.00 - 99946.00 NM	Auto	Select test value for distance.	Yes (1 beep)
6	SIMULATE	On/Off	Off	Speed simulator on/off.	

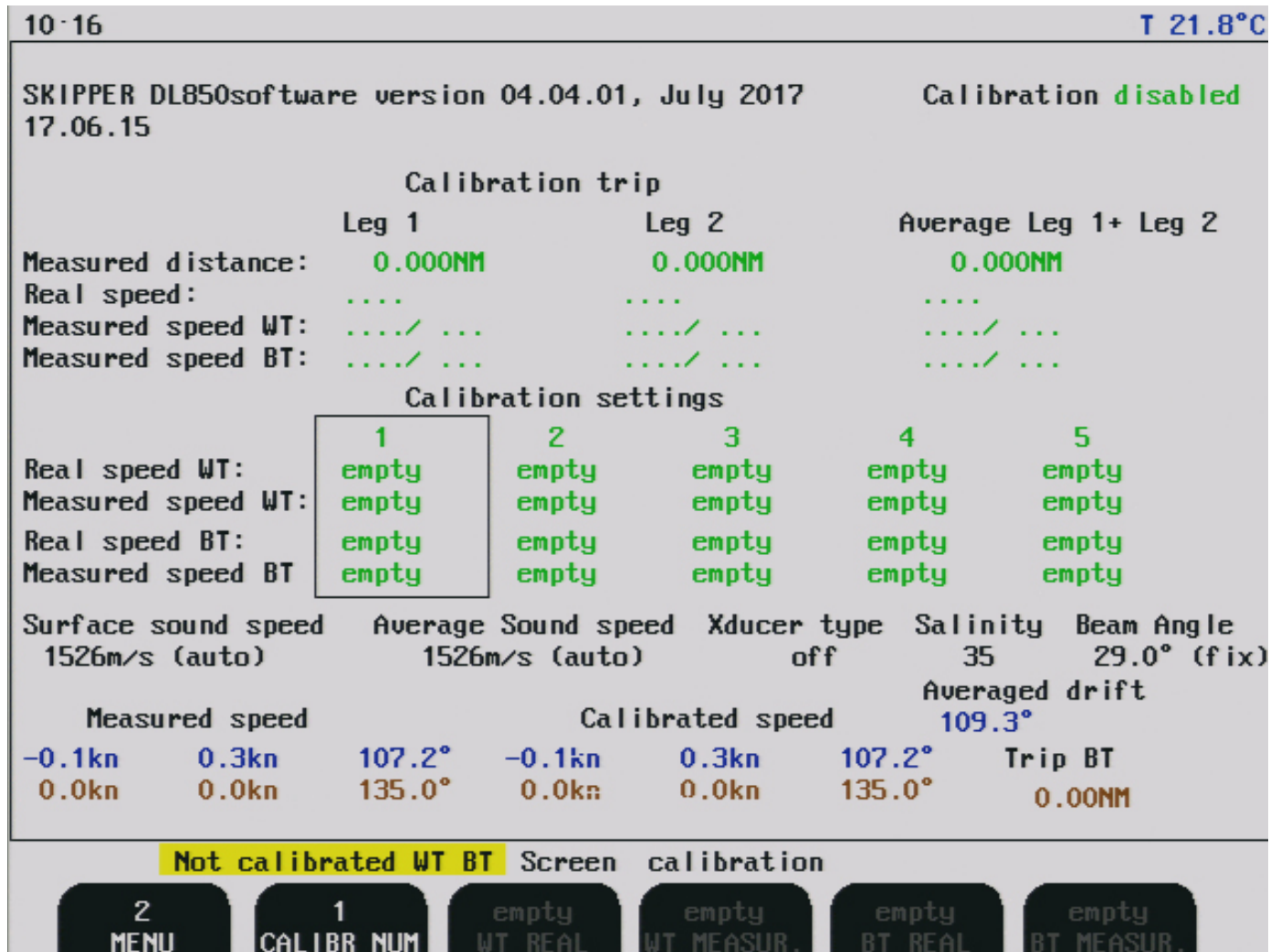

For calibration, see: [“5. Calibration procedure” on page 51.](#)

The calibration screen is default set to "Disabled". To enable calibration please see ["Enabling of calibration" on page 52.](#)

Note: If the system is not calibrated, a warning **"NOT CALIBRATED WT BT"** will flash on the lower left part of the screen.

Screen calibration, Menu 1, Auto calibration.

Softkey	Name	Range/value	Default value	Description	Activate with hidden button
1	MENU	1 - 4	1	Menu 1 is selected.	
2	START	Leg 1 start/finish Leg 2 start/finish	Leg 1	Used to start/finish test trip.	Yes (1 beep)
3	CALIBR	Activate		Used to move data, collected during test trip into calibration table. Note: Active when calibration is within limits	
4	TRIPS LIST	1 - 5	1	Used to list between different test trip data sets. Only one test trip is displayed on the screen at a time.	
5	TRIP BT	On/Off	Off		
6	CALIBR DIS	0.054 - 5.400 NM	1.000 NM	Used to adjust length of the test leg.	

Calibration settings

	1	2	3	4	5
Real speed WT:	7.5kn	empty	empty	empty	empty
Measured speed WT:	7.3kn	empty	empty	empty	empty
Real speed BT:	7.5kn	empty	empty	empty	empty
Measured speed BT	7.2kn	empty	empty	empty	empty

Surface sound speed 1527m/s (auto)	Average Sound speed 1527m/s (auto)	Xducer type off	Salinity 35	Beam Angle 29.0° (fix)
Measured speed		Calibrated speed		Averaged drift 4.4°
-1.3kn	0.0kn	-178.2°	-1.3kn	0.0kn
.....
				Trip BT 0.00NM

Screen calibration

2 MENU	1 CALIBR NUM	7.5kn WT REAL	7.3kn WT MEASUR.	7.5kn BT REAL	7.2kn BT MEASUR.
------------------	------------------------	-------------------------	----------------------------	-------------------------	----------------------------

Screen calibration, Menu 2, Manual calibration.

Softkey	Name	Range/value	Default value	Description	Activate with hidden button
1	MENU	1 - 4	2	Menu 2 is selected.	
2	CALIBR NUM	1 - 5	1	Number on the calibration data set currently available for adjustments. In the calibration table it is marked by the frame.	
3	WT REAL	0.0 - 48.6 kn	Empty	Real ship's water track speed (reference speed).	Yes (1 beep)
4	WT MEASUR.	0.0 - 48.6 kn	Empty	Water track speed, measured by the system.	Yes (1 beep)
5	BT REAL	0.0 - 48.6 kn	Empty	Real ship's bottom track speed (reference speed).	Yes (1 beep)
6	BT MEASUR.	0.0 - 48.6 kn	Empty	Bottom track speed, measured by the system.	Yes (1 beep)

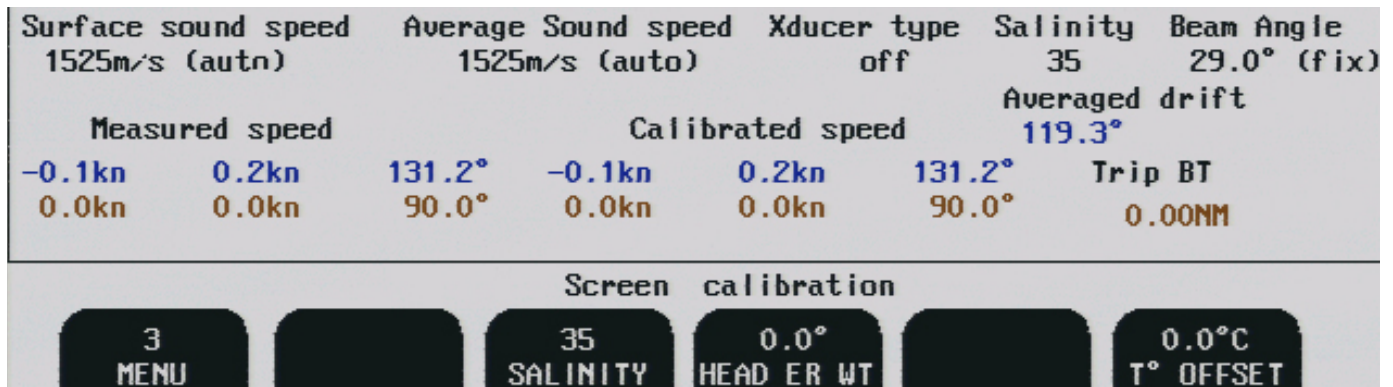

Screen calibration, Menu 3, mounting settings.

Softkey	Name	Range/value	Default value	Description	Activate with hidden button
1	MENU	1 - 4	3	Menu 3 is selected.	
2				Not used.	
3	SALINITY	20-35	30	See appendix 5	Yes (1 beep)
4	HEAD ERR	-30.0° - 30.0°	0.0°	Installation angular error correction. (Seen by "averaged drift" during speed operation.)	Yes (1 beep)
5					
6	T° OFFSET	10.0°C -10.0°C	0.0°C	Temperature offset correction.	Yes (1 beep)



Screen calibration, Menu 4, mounting settings.

Softkey	Name	Range/value	Default value	Description	Activate with hidden button
1	MENU	1 - 4	3	Menu 4 is selected.	
2					
3					
4					
5	SOUND SURF	1400-1550	Auto	Speed of sound in water.at surface	Yes (1 beep)
6	SOUND AVER	1400 - 1550 m/s	Auto	Speed of sound in water. average of STW area	Yes (1 beep)



Screen diagnostics, Menu 1, Details Off.

Soft-key	Name	Range/value	Default value	Description	Activate with hidden button
1	MENU	1 - 3	1		
2	DIAGNOSTIC	On/off	Off	Start self diagnostics procedure, The results will be shown in the 'test results' frame, and advice based on the results, will be displayed in 'possible reasons'. More info in section “Typical diagnostic screen contents.” on page <?>. Note: Diagnostics not available in Demo/Simulate mode.	
3	DETAILS	On/Off	Off	Details Off: Only diagnostics results shown Details On: Doppler signal and frequency of each channel shown for diagnostics use.	
4	RECORDINGS	On/Off	Off	If necessary, the user can log all relevant raw data to the Compact Flash disk. This data will be stored in an internal proprietary format that can be analysed upon request.	
5					
6					

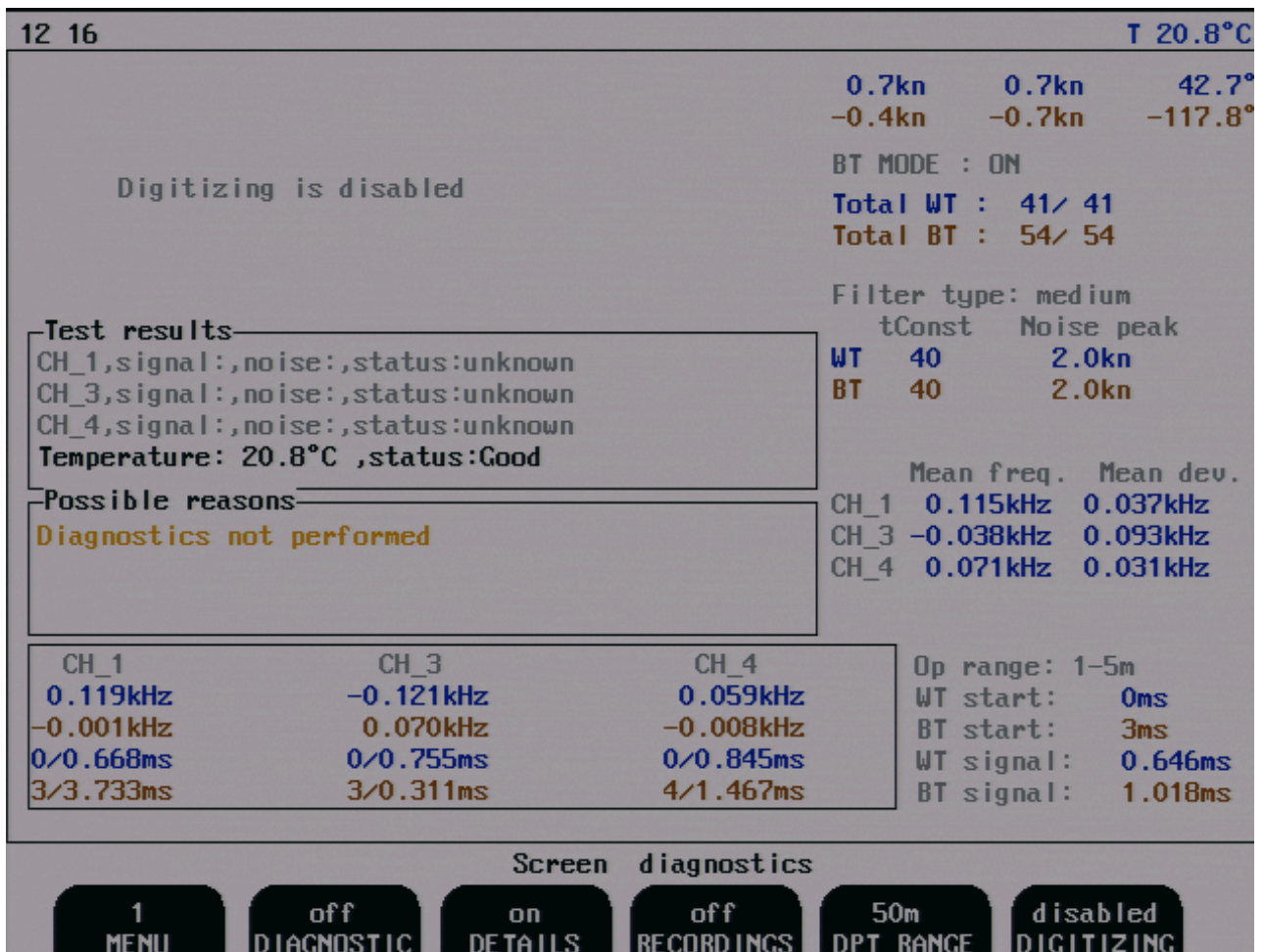

Screen diagnostics, Menu 1, Details On.

Soft-key	Name	Range/value	Default value	Description	Activate with hidden button
1	MENU	1 - 3	1		
2	DIAGNOSTIC	On/off	Off	Start self diagnostics procedure, The results will be shown in the 'test results' frame, and advice based on the results, will be displayed in 'possible reasons'. More info in section " Typical diagnostic screen contents. " on page <?>. Note: Diagnostics not available in Demo/Simulate mode.	
3	DETAILS	ON/OFF	OFF	Details Off: Only diagnostics results shown Details On: Doppler signal and frequency of each channel shown for diagnostics use	
4	RECORDINGS	On/Off	Off	If necessary, the user can log all relevant raw data to the Compact Flash disk. This data will be stored in an internal proprietary format that can be analysed upon request.	
5	DPT RANGE	5-150m	50m	Depth range to be used in the digitizing scope.	
6	DIGITIZING	Disabled, wt ch1, wt ch3, wt ch4, bt ch1, bt ch3, bt ch4.	Disabled	This function allows to display oscillogram in the graphical window from any channel in both water track and bottom track modes. It will allow examining shape and amplitude of the returned signal in each individual channel. Note: This function delays signal processing and must be set to "Disabled" during normal operation to reduce latency of the system.	Yes, (2 beeps)



Screen diagnostics, Menu 2, filtering/averaging.

Soft-key	Name	Range/value	Default value	Description	Activate with hidden button
1	MENU	1 - 3	2	Menu 2 is selected.	
2	FILTER	Low, Medium, High, Run. Aver	Medium	Selects speed filtering parameters. Run Aver: This is a simple running average taking the user selectable number of points and averaging these to give the output result. Low, Medium, High: These are preset values for a threshold filter.	
3	WT tCONST	1 - 155	40	Number of individual samples to be averaged in WT mode to provide better accuracy.	Yes (2 beeps)
4	WT NOIS. PK	0.2 - 3.9 kn	2.0 kn	Noise threshold referred to the calculated mean value used in water track. Note: “Dimmed” if “Run. Aver” is selcted as filter setting (softkey 2).	Yes (2 beeps)
5	BT tCONST	1 - 155	40	Number of individual samples to be averaged in BT mode to provide better accuracy.	Yes (2 beeps)
6	BT NOISE. PK	0.2 - 3.9 kn	2.0 kn	Noise threshold referred to the calculated mean value used in bottom track. Note: “Dimmed” if “Run. Aver” is selcted as filter setting (softkey 2).	Yes (2 beeps)

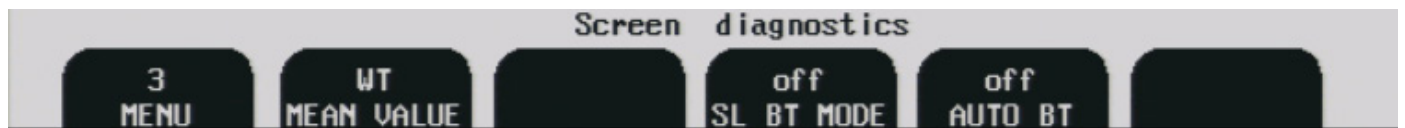

Screen diagnostics, Menu 3, BT settings.

Soft-key	Name	Range/value	Default value	Description	Activate with hidden button
1	MENU	1 - 3	3	Menu 3 is selected. Note: Press MENU softkey and use encoder to get access to menu 3.	
2	MEAN VALUE	WT/BT		Mean values in “details on” will show mean from WT or BT signal	
3				Normally not used	
4	SL BT MODE	On/off	On	Enabling/Disabling individual BT samples, which are only executed, when the operating range is 25m or lower. Can be used for trouble shooting and factory testing. Must be switched on at normal operation.	Active when AUTO BT is off.
5	AUTO BT	On/off	On	Toggle automatic bottom track. If switched on, bottom track sampling rate is automatically reduced if the present water depth is greater than bottom track operating range. If AUTO BT is switched off, bottom track function will operate continuously, but still only give BT speed indications within the range for bottom track.	Yes (2 beeps) Only active when “Details ON”
6				Normally not used	

Important note: In case of accidental changing of some parameters, which causes serious malfunction, reset all parameters to factory defaults. See [“RESET FACTORY” on page 26](#)

Principal Functions

Doppler Log Principle

The Doppler log works on the principle of detecting Doppler frequency shifts, i.e the phenomena of a perceived frequency being dependent on the relative speed of the emitting and receiving systems.

$$\Delta f = \frac{2v}{c} f$$

Observed frequency shift Δf .

Emitted frequency f .

Measured velocity, v .

Speed of sound in water, c .

A short burst of a known frequency is emitted into the water, and the frequency of the received echoes are measured. The difference between the emitted frequency and the received frequency makes it possible to calculate the relative speed. If the reflecting body is the bottom, the measured speed will be relative to ground. By measuring the reflections from the particles in a near water layer, a relative water speed may be obtained.

Bottom Track Characteristics

DL850 will try to acquire a bottom track when the depth is between 2 and ca. 150 m, depending on the bottom conditions. In this case, both bottom track and water track data will be acquired.

Water Track Characteristics

Water relative speed is measured at a depth of. 0,3-16 meter below transducer. (Depending on setting and depth). Alternatively using NAUT setting (See “NAUT rules” on page 89) the water track can be fixed to allways measure within 0,3-3 meter. Water track detected in depths less than 2m will include interference from bottom track.“

Docking Function - (Only in Docking version of Display unit)

Docking function is a feature for navigators which have a need of the transversal speed aft the ship. Instead of installing a second sensor aft, (which will normally cause problems due to turbulence under the sensor) the movement of the ship is calculated using the forward sensor and the gyro compass's rotation signal. Provided the ROT (Rate of Turn) signals fulfil the IMO standards (IMO Resolution A.526 (13)) and the Doppler sensor is installed and operating correctly, the transversal speed aft of the ship will be calculated to the required accuracy of 0.2 kn.

The longer the vessel, the more accurate the requirement of the Doppler sensor. The accuracy of the sensor can be increased by increasing the averaging time of the system, or the size of the measurement sample (cell). The software will calculate the optimum averaging and cell size, based on the requirement spec of the system and set this as the default value. It is likely the averaging can be reduced to give a faster response as most systems have an actual performance better than the requirements. During installation, parameters for the ship length at waterline and distance between the bow and sensor must be entered into the log. These parameters are used for calculating the aft speed.

Non-volatile Parameter Memory

The system contains memory to maintain installation and user parameters like unit of measurement,

back light settings, etc. These parameters are kept in the Compact Flash (CF) memory card, and are automatically restored on power up. If the user parameters have never been set, default values are used.

There are 2 ways to reset the parameters to default values:

“Master Reset” will reset all parameters to default

“Reset Factory” will reset all parameters except I/O and calibration settings. .

Diagnostic functions

Built in test (BIT)

Built in test (BIT) is a function that runs a series of tests to try to find known errors within the system.

There are 3 built in test in the DL850.

“Screen status” “Link to transceiver” Automatic test of communication Display-Transceiver.

“Screen status”, “System” Test of signal from sensor to Display.

“Screen diagnostics” The diagnostics ON will test the internal noise in the sensor and signal strength of the water track signals from all 3 channels.

The BIT is developed to help discover and diagnose a possible problem. It is a tool to diagnose but may not give an accurate fault description in all situations. It will not find all problems, but if it recognises a problem, it will give the result in the frame marked ‘ Possible reasons’. More information about the tests is available on the manufacturers web pages.

Digitizing Scope

The Diagnostics screen has a “DIGITAZING” function allowing the user to look at the individual returned waveforms on each of the sensors transducers, both in the water track ping and bottom track ping. This allows the user to diagnose faults on the individual beams.

“Screen diagnostics”, “Details ON” then choose channel and WT/BT to show.

3. User Maintenance

Transducer Maintenance

The transducers are virtually maintenance free, but occasional cleaning may be necessary to remove growth/shell (The acoustic signal may be decreased if extensive shell grow on sensor)

Operator Unit and Transceiver Unit Maintenance

The operator and transceiver unit contains no user serviceable parts, and requires no maintenance apart from occasional cleaning of the front panel. Please use a soft cloth and **no chemicals** except **cleaning alcohol**.

Note: Dry docking the vessel. The transducer will only tolerate short periods in air. When the vessel is placed in dock, or the transducer is lifted, the power must be shut off at the switch or circuit breaker. The softkey SYSTEM off only places the system in standby, and power glitches may activate the system.

4. Installation

This chapter contains information related to installation of the Doppler speed log. Please ensure you perform all the following subsections:

- Installation of bottom parts/transducer. See
- Operator unit installation, see [“Operator Unit Installation” on page 37.](#)
- Interfacing, see [“Operator Unit - Connecting External Equipment” on page <?>.](#)
- Selecting voltages, see [“115/230 V selection on Combo Terminal board inside Display Unit” on page 37.](#)
- Connecting the transceiver unit. (See [“Transducer Installation” on page 35\).](#)
- Checking (see [“5. Start-up and system adaption” on page 35\).](#)

Handling warning

- **The Doppler system is a sensitive measuring device, all parts must be handled carefully. Please pay particular care with handling of the bottom parts and follow all instructions with regards to handling and installation.**
- **The transducer is supplied with a foam packaging. Keep this in place until the sensor is placed in the valve.**

Standard System Supply

A basic Doppler system consists of the following units (see [overview drawings in chapter “10. Appendix 1” on page 35\).](#)

- Display/operator unit.
- Communication cable (if ordered, else yard supply).
- Transceiver unit.
- Sensor cable.
- Transducer (sensor).
- Bottom parts, usually a sea valve assembly.

Transducer Installation

For bottom part installation and placement, see separate manuals.

Additional manuals are available from your supplier (contact information on cover page).

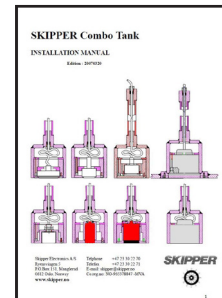
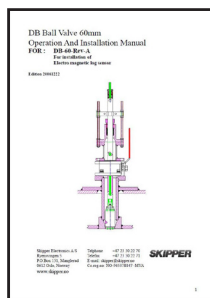
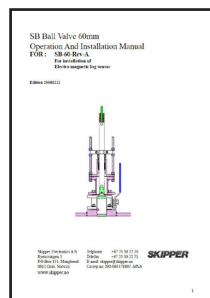

Location

- The transducer must be install in foreship.
- Optimal system operation is achieved by fitting the transducer as deep as possible on the hull.
- The transmitting surface of the transducer must be installed horizontal.
- Do not mount transducers aft of the bow thruster propeller outlets, or aft of other hull installations (outlets, vents or other protruding details).
- It is necessary to select a part of the hull that is submerged under all load and speed conditions, and to avoid positions where air is trapped in heavy weather.
- If a flat, horizontal section is not available for transducer fitting, the shipyard must construct a suitable bed.

Protect the active element of the transducer and **do not paint the surface.**

Minimum bending radius of sensor cable is 222mm. During installation, consideration must be taken, such that the sensor and cable can be removed for service purposes. Filling pipes or tubes is not recommended unless strictly necessary.

Note: See [chapter “10. Appendix 1” on page 36](#) for more information about connecting transducer to transceiver cabinet.

Important note: During installation, **DO NOT CUT THE TRANSDUCER CABLE.** The transducer, transducer cable and transceiver cabinet are all “balanced parts”. Therefore cutting the cable may deteriorate performance and will also void the warranty.

Operator Unit Installation

Select a position to provide free view of the panel as well as easy access during operation and service. The operator unit may be mounted flush in a panel, on a wall or directly onto a bulkhead. For more information, see [“Dimensional Drawing Cabinet” on page 78](#), that shows the operator unit along with the main installation drawings. If the unit is to be flush mounted, the shown cut-out and recession depth dimensions must be observed. Remember to leave room in front of the unit to open the door a full 90°.

Do not perform installation work with system power applied!

Cables are led through the appropriate cable glands as follows:

- The cable from the transceiver unit should normally occupy the left gland.
- The right gland is used for power supply connection.
- The centre ones are used for any interface signals connected.

115/230 V selection on Combo Terminal board inside Display Unit

Power supply may be either 115/230 V AC or 24 V DC. Power consumption is app. 50 W at 24 V DC and app. 70 W at 115/230 V AC. If the AC power system is 115 V, the system must be prepared for 115 V by re-connecting the connectors J102, J103. Fuses are shown in fig. 4.1 for 115/230 V AC and 24 V DC. These fuses are normal 5 x 20 mm slow blow glass fuses.

When the installation is complete, and power is connected to the operator unit, the appropriate power switch next to the power terminals is switched on.

For daily operation, these switches may stay on and the unit is switched off by pressing the “SYSTEM off” button. The unit is switched on by pressing any button.

115/230 V AC and 24 V DC power may be connected and switched on at the same time. If one of these supplies shuts down, change over is automatic.

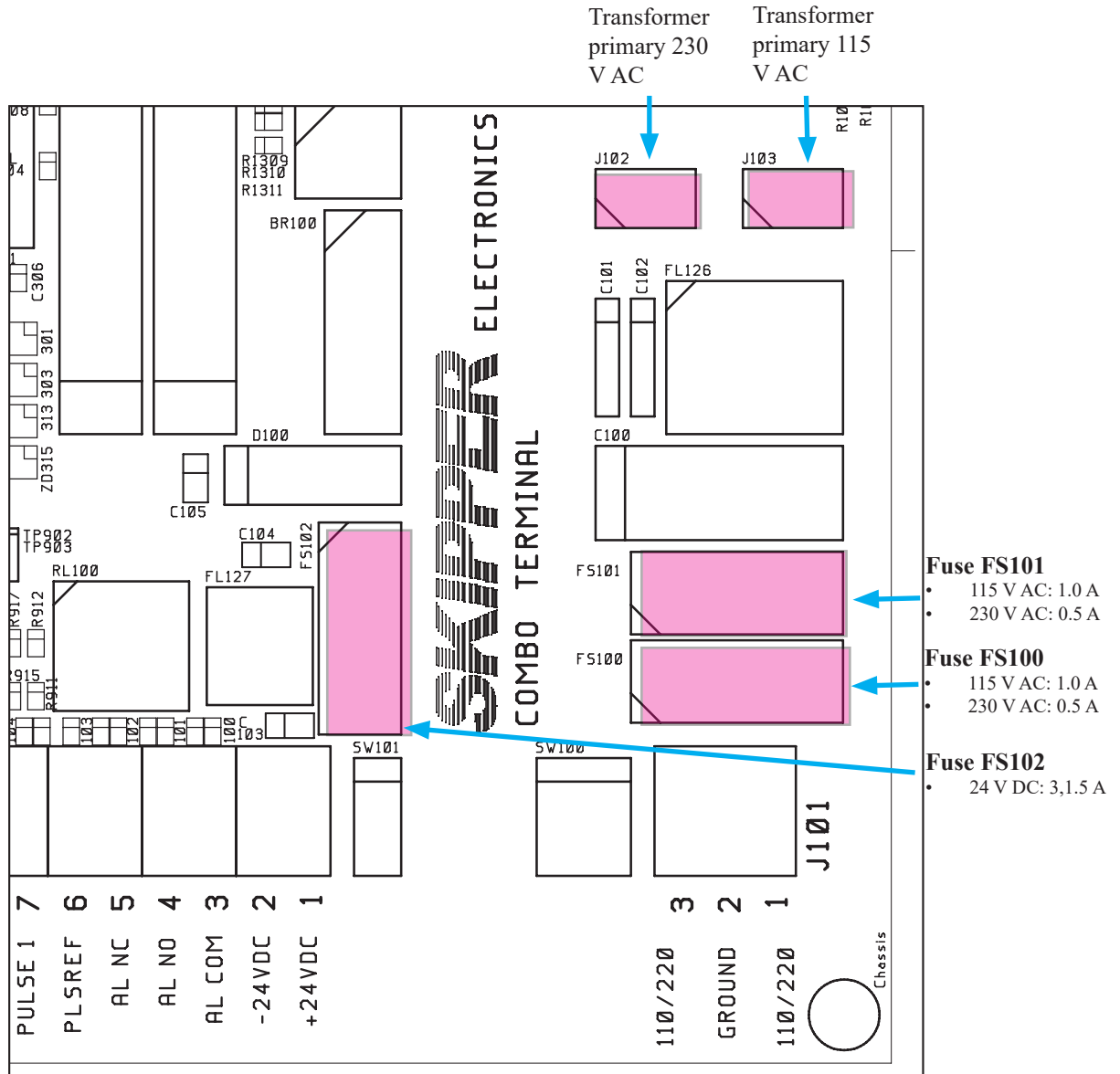

Fig. 4.1 Voltage selection connectors and fuses, Terminal Board.

AC Voltage selection

- Transformer primary to: J102 for 230 V AC and J103 for 115 V AC.
- Fit dummy plug on opposite connector for protection.

Fuses

- 230 V AC: FS100 and FS101 must be 0.5 A slow blow.
- 115 V AC: FS100 and FS101 must be 1.0 A slow blow.
- 24 V DC: FS102 must be 3.15 A slow blow.

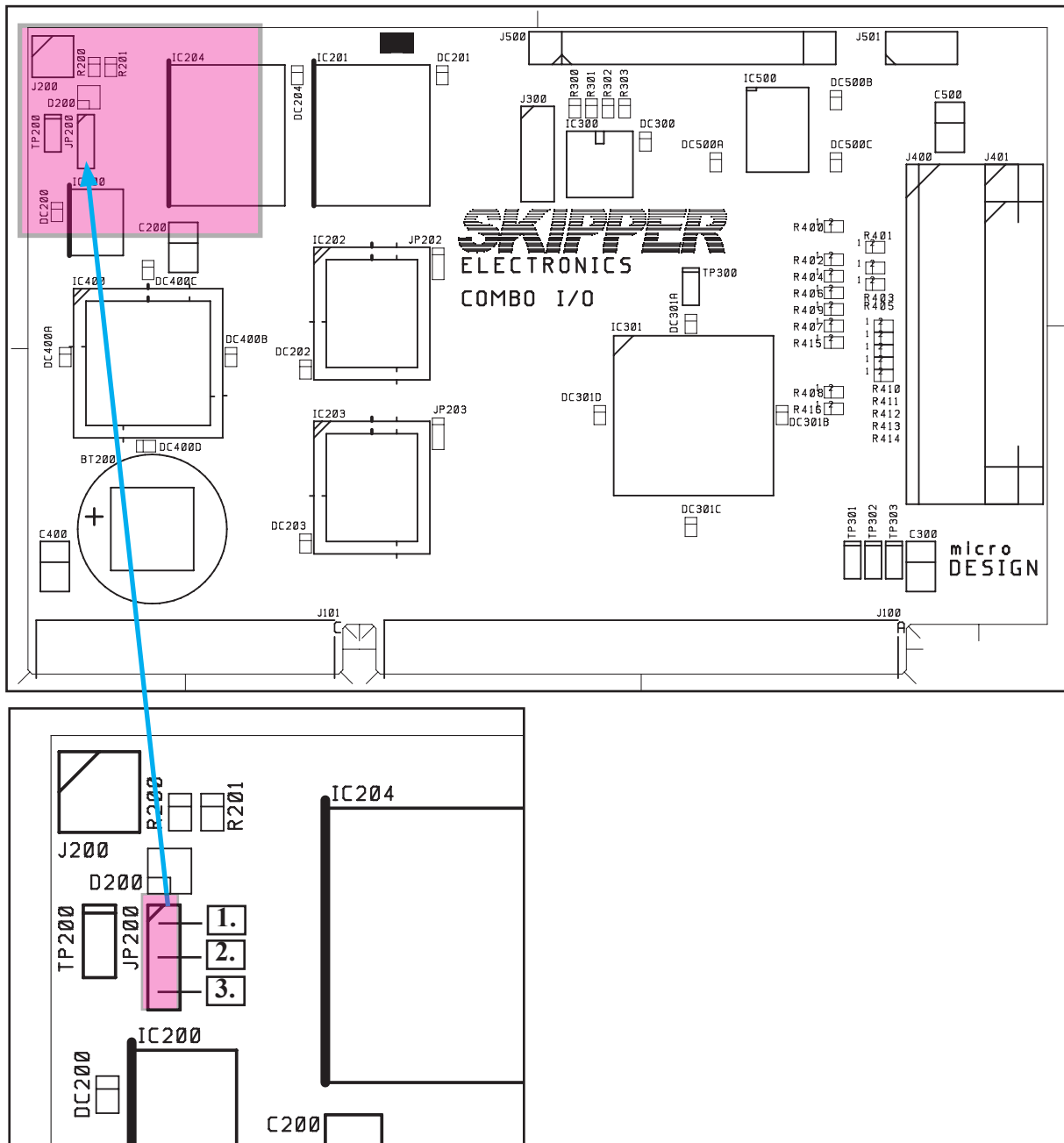

Fig. 4.2 Static Memory Battery Jumper, I/O Board.

Back-up Battery Jumper JP200

The battery back up memory on I/O PCB is not in use from SW version 4.03.04 and up. Refer to Fig. 4.2 for the correct setting of the battery jumper “OFF” position 1-2.

This jumper should be set to the “ON” position 2-3 only on software version 4.03.03 or lower.



Fig. 4.3 Function LEDs, on terminal board

Power indication and function LEDs

The following LEDs are located on the terminal board:

- LD400 NMEA signal activity on receive input 1.
- LD401 NMEA signal activity on receive input 2.
- LD700 +5 V#1/VCC (board external and CPU).
- LD701 +12 V#1/VDD (board external).
- LD702 +5 V#2 (board internal).
- LD703 +12 V#2 (board internal).
- LD704 -12 V.
- LD705 -5 V.

Fig. 4.3 indicates position of these LEDs.



Important note: If, after power-up, on screen status, you see the following message “Receiver PLD rev: 0.0.00” in the upper right corner, this is an indication of old PLD in the transceiver unit. The unit will work, but is not optimized. Replace PLD with correct version, (1.0.00) or contact your local supplier for more information.

Part number: LG-T001

Operator unit External connections



SKIPPER DL 850
 DOPPLER SPEED LOG Operator Unit
 Type / Part.no : DL850-DD-SA Rev.: 01
 Serial number : DOU-06293
 COMPASS SAFE DISTANCE
 STEERING : 0.25m STANDARD : 0.5m
 SUPPLY VOLTAGE : 20 - 32 VDC
 115 / 230 VAC DNV 0575/06
 MADE IN NORWAY
 SKIPPER ELECTRONICS AS

- 5 x PG 13.5 cable entry 10-12 mm
- Ground Stud
- XJ402: NMEA ports D-SUB 9 pin female
- XCN6: VGA terminal HDD-SUB 15 pin female
- XCN3: Not used D-SUB 25 pin female

If required, the PG glands can be moved to other blinded holes. Extra holes are also available on back side of cabinet.

Operator unit - Terminal PCBconnections

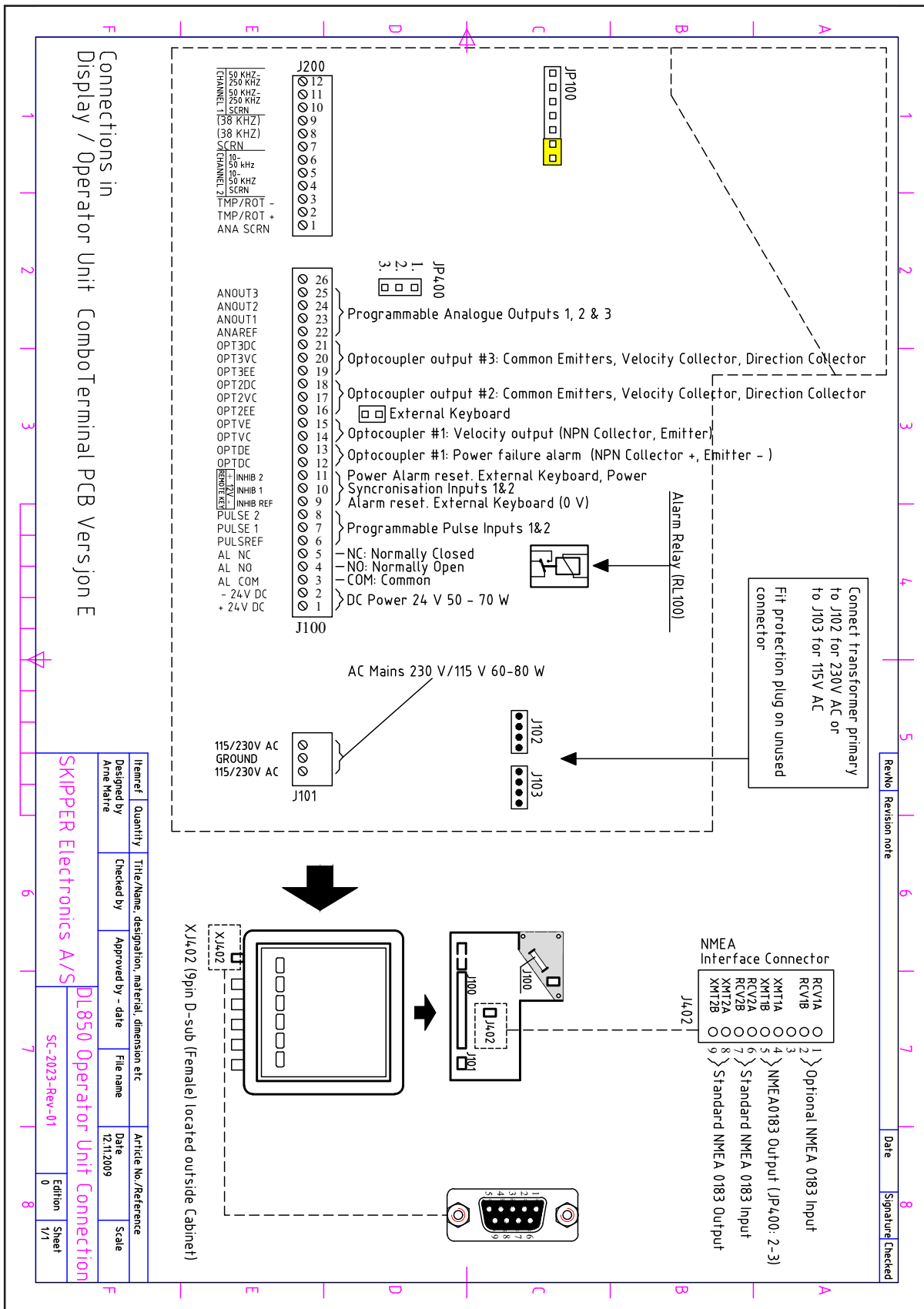
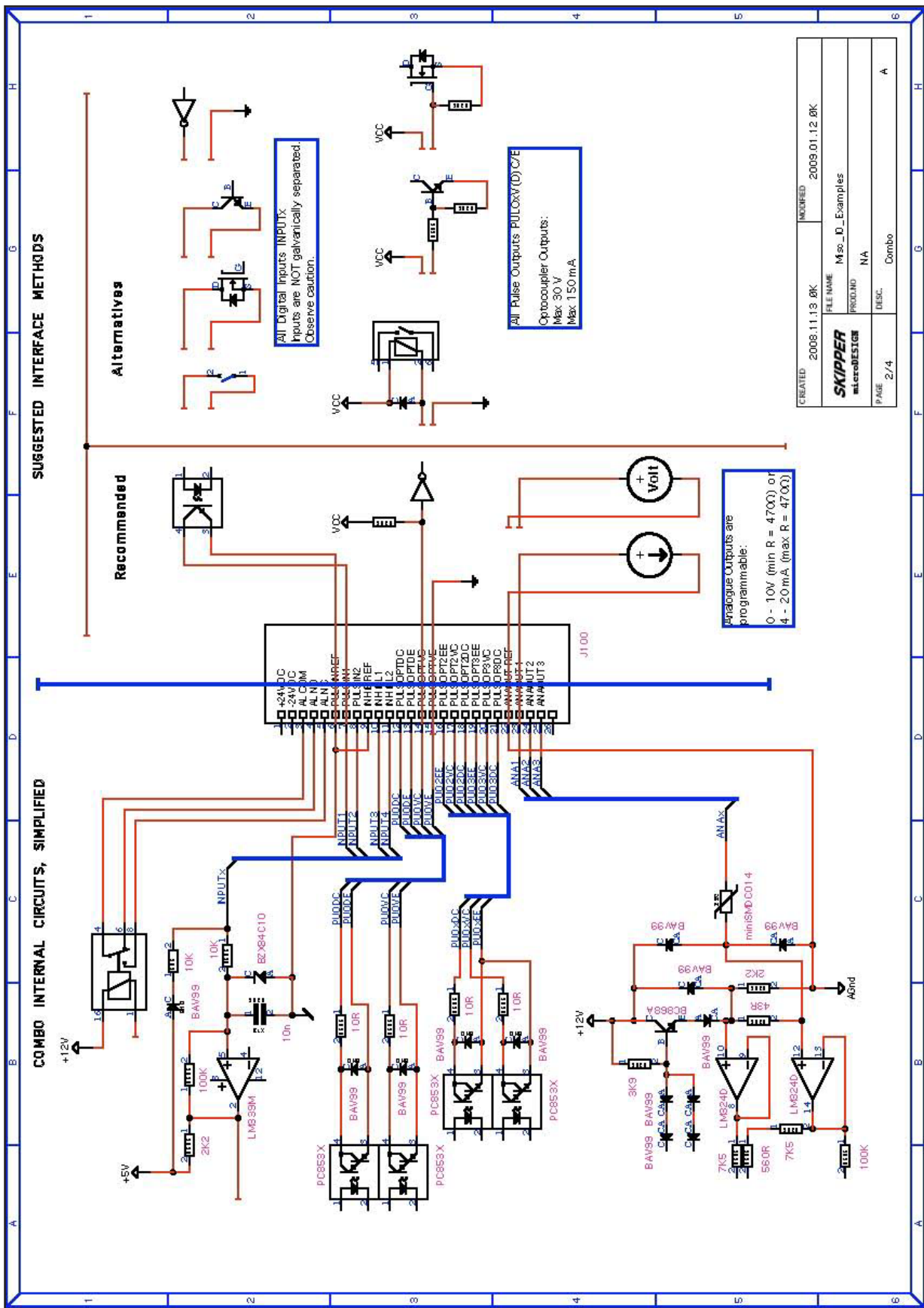

Fig. 4.5 Terminal connections

Examples of optocoupler I/O connections



CREATED	2008.11.13 BK	MODIFIED	2009.01.12 BK
FILE NAME	Misc_ID_Examples		
PROJ.NO	N/A		
DISC.	Combo		
PAGE	2/4		A

Fig. 4.6 Misc I/O connections

Alert relay connections

Power failure relay

A relay is provided for interconnection to external alert systems. This relay is normally energized, and is released by power failure/power off. The terminals have the following significance:

Pin nr	Name	Description
J100 - 3	AL COM	Common terminal.
J100 - 4	AL NO	Normally open contact.
J100 - 5	AL NC	Normally closed contact (normal = "No alarm" condition).
J100 - 12	OPTDC	.
J100 - 13	OPTDE	

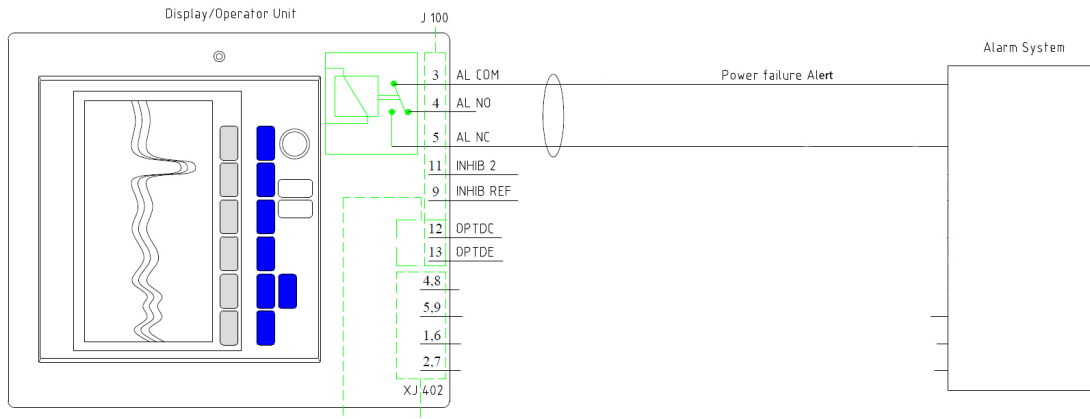

Fig. 4.7 Power failure connections

Log Pulse Outputs

Pulse output terminals are as follows:

- Each group of pulse outputs are galvanically separated.
- All pulse outputs are opto couplers.
- The pulse rates and output modes are programmable in [“Screen status, Menu 4, pulse settings.” on page 25.](#)
- Possible pulse rates are 10/100/200/400/1000 pulses per nautical mile. (1000 pulses Ch 3 only).
- Possible output modes are ForAftWT, LateralWT, ResultWT, ForAftBT, LateralBT, ResultBT.

Pin nr	Name	Description
J100 - 21	OPT3DC	Optocoupler 3, direction collector.
J100 - 20	OPT3VC	Optocoupler 3, velocity collector.
J100 - 19	OPT3EE	Optocoupler 3, common emitters.
J100 - 18	OPT2DC	Optocoupler 2, direction collector.
J100 - 17	OPT2VC	Optocoupler 2, velocity collector.
J100 - 16	OPT2EE	Optocoupler 2, common emitters.
J100 - 15	OPTVE	Optocoupler 1, velocity emitter. Pulses ch 1, or speed limit function when activated.
J100 - 14	OPTVC	Optocoupler 1, velocity collector. Pulses ch 1, or speed limit function when activated.

Pulse output is default set to water track in Fore/Aft direction (ForAftWT). For special purposes as ship maintenance or measuring of travelled distance in rivers, the pulse output may be set to give other types of speed such as ResultWT, ForAftBT or ResultBT. This option is protected and can be activated by using the hidden button as described in the chapter for calibration. See [“Enabling of calibration” on page 52.](#)

Note: If the high speed limit (Sp(ee)d limit ▲) and low speed limit (Sp(ee)d limit ▼) are both equal = 0 kts, the optocoupler output ch 1 (OPTVC and OPTVE) is operating as the standard speed pulse output. If the speed limit values are <> (different from) 0 kts, the optocoupler output ch 1 is designated as speed limit function. (See illustration on screen status on previous page).

Speed Limit function

When the speed limit function is activated, (not 0 in both Sp(ee)d limit ▲ and Sp(ee)d limit ▼ (see status screen)) pins 14 and 15 will be designated this warning. This warning is typically used to limit the systems steering at higher speeds, or to block incorrect usage of equipment that should not be used at high speeds (stabilisers or winches). Upper (▲) and lower (▼) limits can be set on screen status menu 6 to provide a window of operation for this function. When activated, Pulse 1 will not be available.

Note: Optocoupler output OPTVE and OPTVC are (if activated) dedicated to the speed limit function. Switch is closed, if the speed is inside the limits, and open if the speed is outside the limits. If closed contact is required, it must be connected as shown in diagram 4.6, see [“Examples of optocoupler I/O connections” on page 44.](#)

Inputs

Pin nr	Name	Description
J100 - 6	PLSREF	Reference for pulse inputs.
J100 - 7	PULSE 1	Not used.
J100 - 8	PULSE 2	Not used.
J100 - 9	INHIBREF	Reference for inhib inputs.
J100 - 10	INHIB1	Not used.
J100 - 11	INHIB2	Remote silence of alarm buzzer.

Note: Short between INHIB2 (J100 pin 11) and INHIBREF (J100 pin 9) used for remote silence of alarm buzzer.

Analogue interfaces

The display unit is equipped with 3 analogue outputs to supply analogue repeaters or other equipment with analogue signals. The signals are galvanically connected to the cabinet ground. Standard range is 0 - 10 V or 4 - 20 mA. The velocity vectors and output modes are programmable from status screen, menu 5.

Pin nr	Name	Description
J100 - 22	ANAREF	System ground, common negative reference for analogue outputs.
J100 - 23	ANAOUT1	Analogue output 1.
J100 - 24	ANAOUT2	Analogue output 2.
J100 - 25	ANAOUT3	Analogue output 3.

NMEA interface

The NMEA output provides IEC 61162-1:2007(E) (NMEA 0183) format information for other equipment with NMEA 0183 inputs. Default setting is 4800 Baud, 8 data bit, 1 stop bit, no parity. Several messages may be selected on screen COM and the enabled messages are transmitted with maximum interval of 1.8 seconds. The NMEA inputs accept alarm, position, rate of turn, heading and UTC time messages from various navigators and compasses. One output can drive minimum of 10 standard NMEA 0183 inputs.

See chapter [“5. Start-up and system adaption” on page 46](#), for a complete list of transmitted and received messages.

Options

Repeaters/Slaves

Graphic CRT (VGA) or LCD displays or digital slave repeaters may be connected to the system. Most repeaters with speed can be used via the NMEA 0183 output. However, the manufacturer recommends: IR300 and CD401

NMEA interface

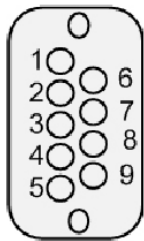

Note: Connector seen from outside.

- NMEA IN: Pin 1-2, RCV1 A, B
- NMEA IN: Pin 6-7, RCV2 A, B
- NMEA OUT: Pin 4-5, XMT1 A, B
- NMEA OUT: Pin 8-9, XMT2 A, B

Pin D-Type NMEA connector XJ402 in cabinet front

NMEA Setup

“Screen COM” is used for verification of received and control of transmitted IEC-61162-1:2007(E) (NMEA 0183) messages. See “[Screen com, Menu 1, NMEA setup.](#)” on page 20 . The 4800 baud rate is the most common, but the baud rate may also be set to other values to interface with different kind of equipment. When a NMEA talker is connected to one of the inputs, all received messages will be displayed on the screen. If no messages are displayed, check the signal polarity, the baud rate and input mode (input, output or off). If messages are marked red, check message protocol. The following messages are accepted for input and interpreted by the program. The talker identifier is ignored.

Time

Day, month, year	ZDA,hhmmss.ss,xx,xx,xxxx,xx,xx*hh<CR><LF>
------------------	---

Position

Geographical lat/lon	GLL,llll.ll,a,yyyy.yy,a,hhmmss.ss,A,a*hh<CR><LF>
GPS position	GGA,hhmmss.ss,llll.ll,yyyy.yy,a,x,xx,x.x,x.x,M,x.x,xxxx*hh <CR><LF>

Rate of Turn

Rate of turn	ROT,x.x,A*hh<CR><LF> (Required for docking.)
--------------	--

Heading

Heading, true, present	HDT,xx.x,T*hh<CR><LF>
True heading and status	THS,x.x,a*hh<CR><LF>

Composite

GPS, transit specific	RMC,hhmmss.ss,A,llll.ll,a,yyyy.yy,a,x.x,x.x,xxxxxx,,,*hh <CR><LF>
-----------------------	---

External trip reset over NMEA

Trip reset	\$PSKPRSTT*hh<CR><LF>
------------	-----------------------

External dimming over NMEA

External dimming of display unit	\$--DDC, a, xx,*hh<CR><LF>
----------------------------------	----------------------------

NMEA sentences transmitted

(talker) (IEC 61162-1:2007(E) (NMEA 0183) messages:

Speed and distance

Name	Description	Example
VTG	Course over ground and ground speed	\$VDVTG,,,,,x.x,N,x.x,K,a*hh<CR><LF>
VHW	Water speed and heading	\$VDVHW,,,,,x.x,N,x.x,K*hh <CR><LF>
VLW	Dual ground/water distance	\$VDVLW,x.x,N,x.x,N*hh<CR><LF>
VLW IEC07	Dual ground/water distance	\$VDVLW,x.x,N,x.x,N,x.x,N,x.x,N*hh<CR><LF>
VBW	Dual ground/water speed	\$VDVBW,x.x,x.x,A,x.x,x.x,A,x.x,A,x.x,A*hh <CR><LF>

When the VBW message is transmitted over COM2, the speed values have 1 decimal point. On all other channels, number of decimals is 2.

Temperature

Name	Description	Example
MTW	Water temperature	\$VDMTW,x.x,C*hh<CR><LF>

Water Current

Name	Description	Example
VDR	Water current	\$VDR, x.x, T, x.x, M, x.x,*hh<CR><LF>

Xx, N Current speed, knots

x.x, MDirection, degrees magnetic

x.x,T - Direction, degrees true

Depth

Name	Description	Example
DPT	Depth	\$IIDPT,x.x,x.x*hh<CR><LF>
DBT	Depth below transducer	\$IIDBT,x.x,f,x.x,M,x.x,F*hh<CR><LF>
DBK	Depth below keel	\$IIDBK,x.x,f,x.x,M,x.x,F*hh<CR><LF>

Values will be preceded with sign as needed (e.g “-“ = Astern, Port).

*hh = Checksum.

Quality

Name	Description	Example
STA	Quality	\$PSKPVDSTA,<wsl>,<wst>,<bsl>,<bst>,<wal>,<bal><checksum><CR LF

A new proprietary NMEA message, indicating the quality of the information from the sensor has been implemented. The format is the following:

<wsl> - WT (speed through water), signal quality in %, longitudinal axis.

<wst> - WT (speed through water), signal quality in %, transversal axis.

<bsl> - BT (speed over ground), signal quality in %, longitudinal axis.

<bst> - BT (speed over ground), signal quality in %, transversal axis.

<wal> - WT (speed through water), validation of acceleration in m/(sec)².

<bal> - BT (speed over ground), validation of acceleration in m/(sec)².

- The first 4 fields are presenting 3 levels of data quality % which are based on the percentage of the good measurements samples within the total population, which is defined by the parameter Number of Averages. The values are individual for each operation mode (WT/BT) and for each axis.

Values are in %, where:

- more than 50 % is generally good.
- 25 % - 50 % is generally warning.
- less than 25 % is generally bad.
- The last 2 fields are presenting 3 levels of data quality, which is based on the maximal acceleration within 3 latest successful samples.

These parameters can be used for a bridge system to predict potential problems and switch to a secondary system.

5. Calibration procedure

Speed logs are calibrated in the factory to give reasonable results after installation, however installation and hydrodynamics vary from vessel to vessel. It is therefore necessary to calibrate speed logs once in place.

SKIPPER speed logs have two parameters that need to be corrected by calibration.

1. Angular sensor installation error (heading error).
2. Speed variations due to drag or mounting tilt.

1. Heading Error



The heading error parameter corrects for an angular offset in mounting. This offset will result in a rotation of the measurement axes. The resultant speed will be unaffected, but the longitudinal and transversal components will be incorrect. An offset will result in the vessel typically showing too much transversal speed, but may also result in speed calibration failing (i.e. initial calibration fails when further points are added). This offset will show itself as an averaged drift on the calibration.

Reducing Heading errors. Sea valves can be manually adjusted to ensure the sensor is correctly aligned. Alignment and heading offset are directly connected. To minimize the offset, the sensor should be mounted pointing ahead.

- **Tank mountings** have ahead marks on both the tank and the sensor insert.
- **Sea valves** have a flat mark on the port side of the pole (Figure 6.1).

2. Speed variations due to drag or mounting tilt.

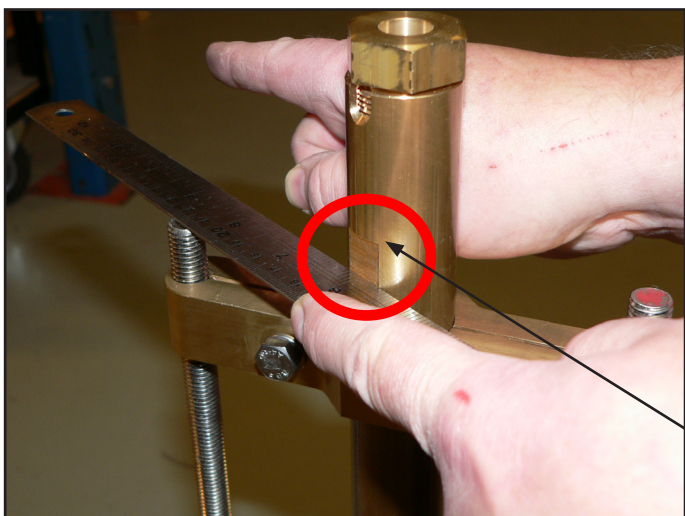

A flat object points fore/aft.

Fig 6.1 Sea valve alignment

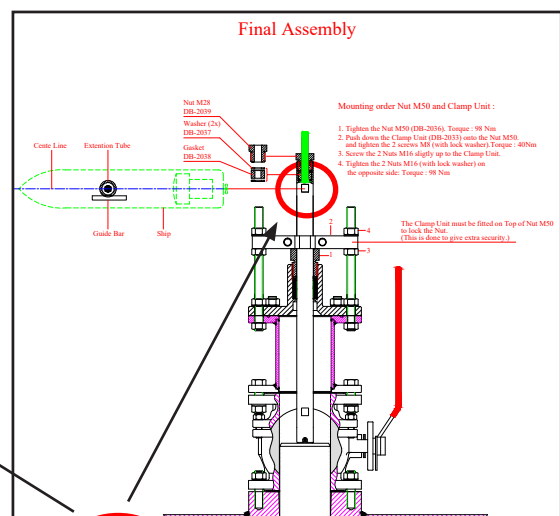

The flat side should be on the port side.

Every vessel will drag some water when it moves. This occurs over the whole hull. As you move further from the hull, the effect of the ships movement gets less. As the vessel moves at different speeds, the hydrodynamics of the vessel may change. In most cases the drag is even over the whole range of the vessel.

Speed logs that measure on the surface of the vessel (such as EML) are

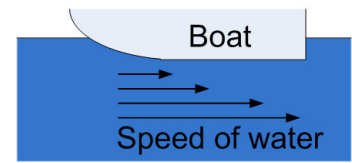

more affected by this factor than sensors that measure remotely (Doppler). The calibration variation is usually less on remote sensors.

As the calibration factors can vary at different vessel speeds, it is possible to calibrate several speeds. It is typically necessary with only one high and one low speed. Speed logs with speed over ground can be compared with GPS speed over ground in stable conditions. However speed through water measures the influence of currents on the vessel, which cannot normally be measured on any other system. It is therefore important that full calibration is performed at least once for speed through water.

Calibration routine:

As previously explained, there are two factors to be calibrated, heading error and speed. Speed over ground can be calibrated in two ways. Speed through water can be approximated, but should be calibrated by sailing on opposite courses to get an accurate value.

All calibration functions are located on the **Calibration** screen. In order to select this screen, press “SCREEN SELECT” button in the lower row of the panel buttons and while keeping it pressed, turn encoder until desired screen appears on the display.

Enabling of calibration

To avoid accidental access to the internal settings, all calibration functions are disabled during normal operation. In order to enable them, do the following:

- Open front door of the cabinet and find a “hidden” key on the component side of the keyboard PCB (upper/left corner of the PCB).
- Press key mentioned above and keep it pressed for 2-3 seconds, until “Calibration **enabled**” message is observed in the right/upper corner of the screen. The text on the soft keys will change colour from grey to white, which indicates availability of the corresponding functions.

After calibration is finished, disable access to the calibration functions simply by pressing the key again. Calibration mode is also disabled after a power recycling.

Step 1. Heading error correction:

The vessel sails a steady course in calm waters and the user reads the resultant angle (averaged drift). This is entered into the system using the **Head err** button and encoder on menu 3, and adjusted until the **averaged drift** angle is zero.

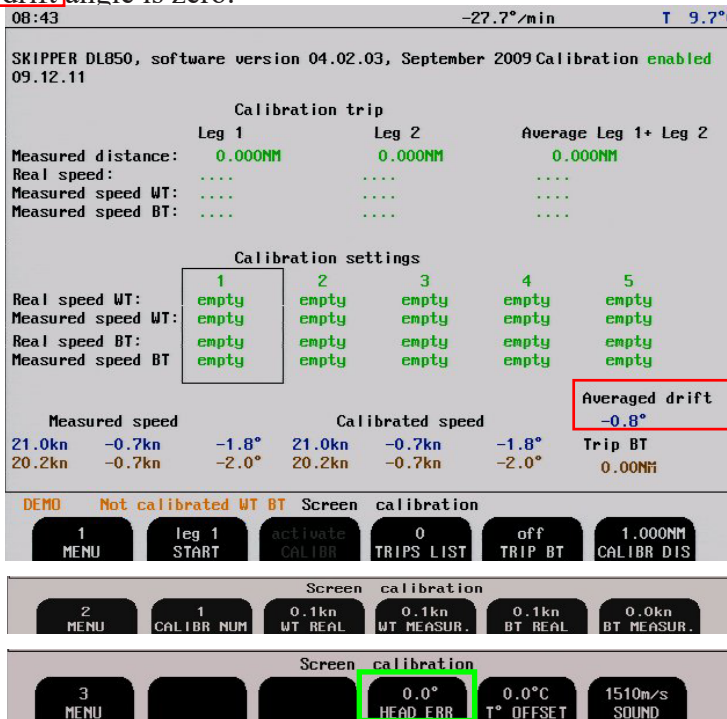

Step 2a. Manual speed calibration/adjustment:

The user enters speed values directly into the calibration table by comparing to other equipment, such as GPS. This can also be used to adjust values. Menu 2 allows you to enter the values directly. Press and hold an empty button will take the current values and place them in the table.

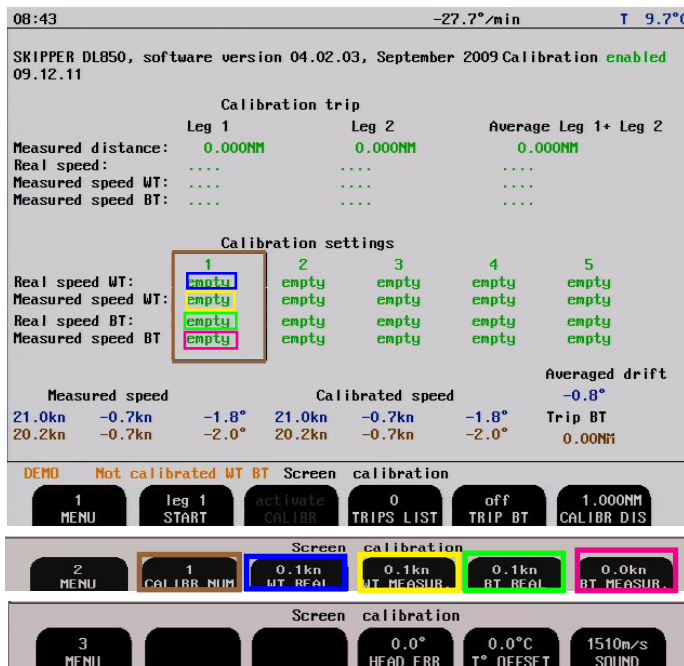

Screen calibration showing manual adjustment.

Placing values in the BT (Bottom Track) fields are valid. Doing this in the WT (Water Track) is not accurate. (Step 2b is recommended).

Step 2b. Semi Automatic calibration:

The vessel is made to sail a known distance and course in both directions. This to remove any water current factors from the speeds.

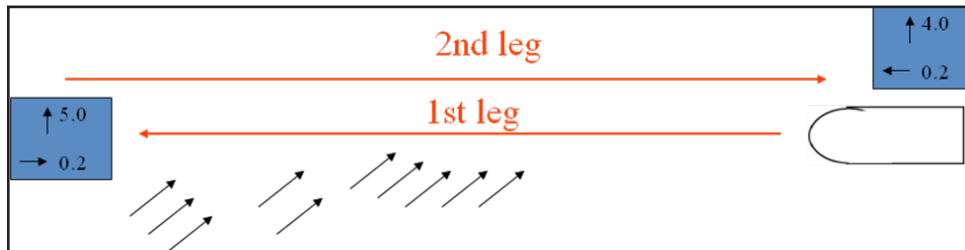

The 1st leg will show a different speed to the 2nd leg, however the direction changes in the second leg so that the average is correct.

The speed can be calibrated as follows:

1. Assuming you have performed step 1 “Heading Error”, plot a known distance on the chart. Enter this value into the **1.000NM CALIBR DIS** on menu 1.

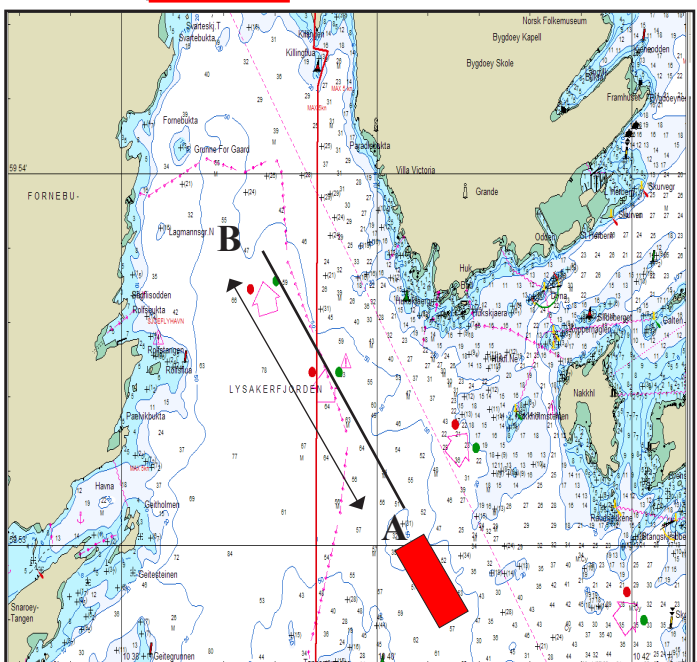
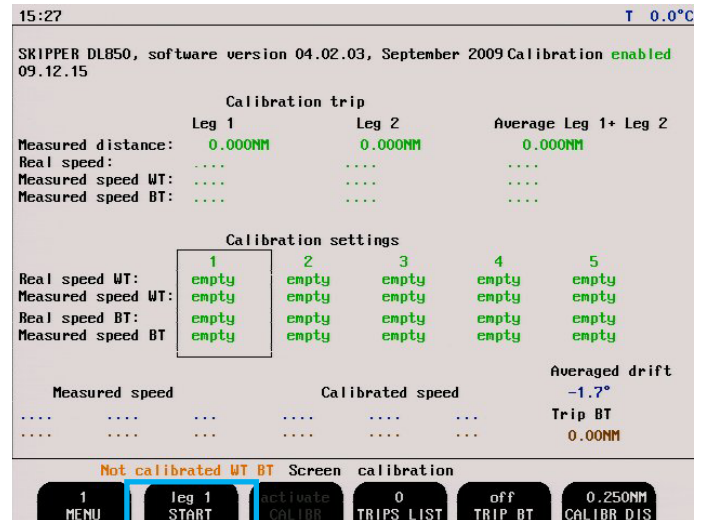
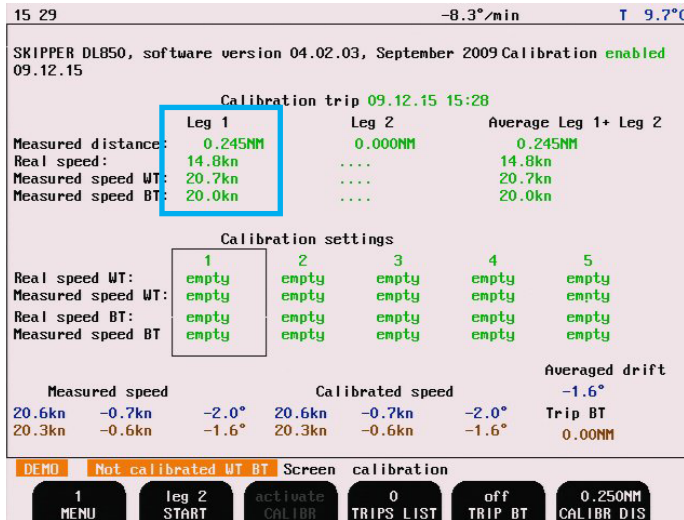

Figure shows plotting a calibration path on the chart.

The leg should take at least 5 minutes to sail (distance can be shorter when sailing slowly). Depth should be < 50 m to ensure that bottom track also calibrates correctly.

- Sail at a straight course in direction A to B and at a constant speed. When passing to point A, Press **START leg 1** on menu 1. The button text will change to stop and a calibrating warning will show on the screen.

Note: Screen menu sw 4.02.03 also valid for 4.03.00



- The **leg 1** measured distance will count up. You may ignore this. When you reach point B, press STOP. The system will then calculate the measured speed (from the measured distance and time) and the real speed (from the Calibr distance and time).
- Turn the vessel and repeat for leg 2 in the opposite

direction at the same speed. The results will show in the Leg 2 table. The average of the two legs will show in the final table. This is the correct calibration.

- If the calibration looks correct, you may select which calibration settings table to place it in, and transfer using the **activate calibr** button (which will be active if the calibration is within limits).
- You have now made a **calibration point**. We

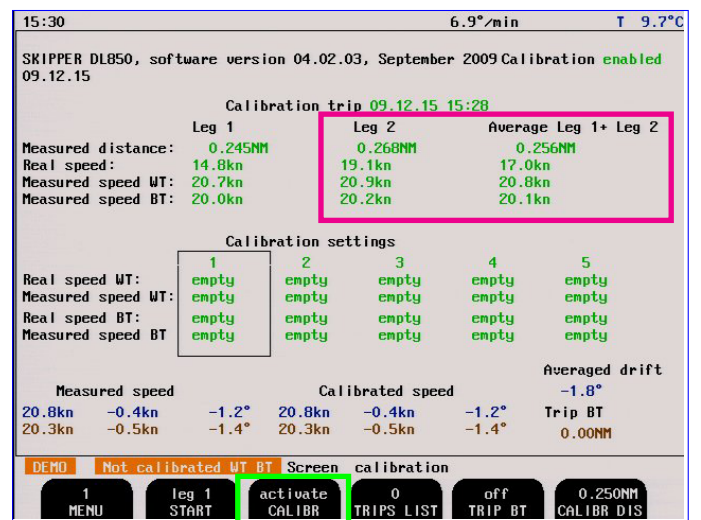
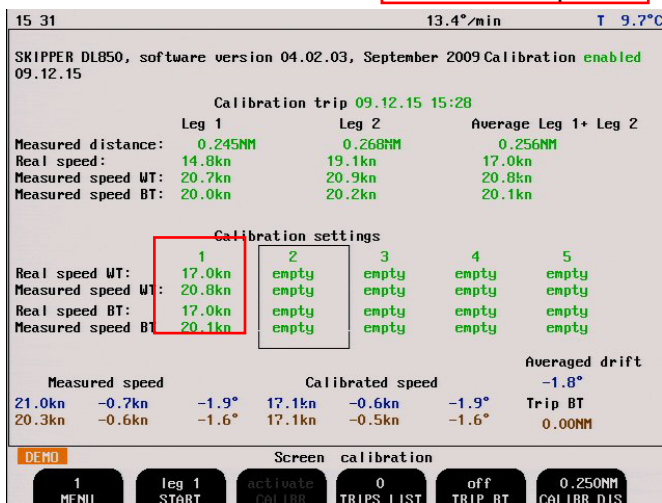

recommend a point at low speed (1-3 kn) and one at high speed (20 kn).

- Once calibrated, check the system at other speeds. If it is inaccurate, you may add more points (max 5).

Note: These values may be overwritten in some software upgrades or if master reset is performed. We advise recording the values somewhere, just in case. Doppler systems typically have a calibration factor within 10 % i.e. measured 9 kn, real 10 kn.

6. Trouble Shooting

Symptom	Cause	Remedy
Basic System Integrity		
No picture on LCD screen.	<ol style="list-style-type: none"> 1. No AC or DC power to the system. 2. System is in standby mode. 3. Too low screen contrast. 4. Defective LCD module. 5. Voltage(s) out of range. 	<ol style="list-style-type: none"> 1. Check switches and fuses on the terminal board inside the DL850 cabinet. 2. Press any button on the panel. 3. Increase contrast settings or replace keyboard PCB. 4. Replace LCD module. 5. Replace terminal board.
Display backlight malfunctions. Display picture is hardly visible.	<ol style="list-style-type: none"> 1. DL850 initialization. 2. Defective backlight tubes. 3. Defective backlight inverter PCB. 	<ol style="list-style-type: none"> 1. Turn off power and wait for 5 sec before restart. 2. Replace backlight tubes. 3. Replace backlight inverter PCB.
Rotary encoder malfunctions.	<ol style="list-style-type: none"> 1. Defective encoder or interface. 2. SW problem. 	<ol style="list-style-type: none"> 1. Replace keyboard PCB. 2. Recycle power/do a "factory reset".
Panel buttons malfunctions.	<ol style="list-style-type: none"> 1. Defective buttons or interface. 2. One button stuck. 3. SW problem. 	<ol style="list-style-type: none"> 1. Replace keyboard PCB or I/O PCB. 2. Check key switch(es) or replace keyboard PCB. 3. Recycle power/do a "factory reset".
Loose user setup and calibration data.	<ol style="list-style-type: none"> 1. Battery backup not enabled. 2. Battery flat. 	<ol style="list-style-type: none"> 1. See "Back-up Battery Jumper JP200" on page 39 for details. 2. Replace battery or I/O board.
Ambient t in status screen shows too high.	<ol style="list-style-type: none"> 1. Obstructed air flow. 2. Defective fan. 	<ol style="list-style-type: none"> 1. Check installations for obstructions of vent holes. 2. Replace fan.

Symptom	Cause	Remedy
Installation problems		
Status screen shows Handshake (HSIN HSOUT). The LEDs on the power and transmitter PCBs inside transceiver cabinet never turns on.	<ol style="list-style-type: none"> 1. Transceiver unit power is off. 2. A pair HSOUTA/HSOUTB on the display side or HSINA/HSINB on the transceiver side is not connected properly to the terminals or wrong polarity of the connection. 3. Damaged communication cable. 	<ol style="list-style-type: none"> 1. Switch on the power in the transceiver unit or check fuses. 2. Check connection and polarity of the handshake lines. 3. Test/replace cable.
Status screen shows Handshake (HSIN HSOUT) The LEDs on the power and transmitter PCBs are periodically turning on and off.	<ol style="list-style-type: none"> 1. A pair HSINA/HSINB on the display side or HSOUTA/HSOUTB on the transceiver side is not connected properly to the terminals or wrong polarity of the connection. 2. Damaged communication cable. 3. Bad connection of the transducer cable. 	<ol style="list-style-type: none"> 1. Check connection and polarity of the handshake lines. 2. Test/replace cable. 3. Check if the transducer is connected to the transceiver unit terminal according to colour diagram in appendix.
Status screen shows Transmit/Receive (TX RX)	<ol style="list-style-type: none"> 1. No connection data lines to the terminal (XMITA/XMITB, RECEIVEA/RECEIVEB) or wrong polarity of the connection. 2. Damaged communication cable. 	<ol style="list-style-type: none"> 1. Check connection and polarity of the XMIT and RECEIVE data lines. 2. Test/replace cable.
Status screen shows Transmit/Receive (TX RX) Noise	<ol style="list-style-type: none"> 1. Cable is not connected to ground or 0 Volt terminal. 2. Missing connection of one of the RECEIVEA/RECEIVEB wires on the display side or XMITA/XMITB on the transceiver side. 	<ol style="list-style-type: none"> 1. Check cable screen. 2. Check connection of data lines.
Status screen shows Transmit/Receive (TX RX) Noise	<ol style="list-style-type: none"> 1. Defective receiver PCB. 	<ol style="list-style-type: none"> 1. Replace receiver PCB.
Status screen shows Transmit/Receive (TX RX) Noise	<ol style="list-style-type: none"> 1. Lock up of the transceiver micro controller due to overheat or strong source of noise close to transceiver unit. <p>Note: Display cabinet will restart process automatically.</p>	<ol style="list-style-type: none"> 1. Check environmental and noise conditions in the area.

Symptom	Cause	Remedy
Interface problems		
NMEA input signals are not listed in the NMEA input screen.	1. Wrong polarity of input signals.	1. Swap NMEA input lines.
NMEA input signals are listed in the NMEA input screen, but not accepted by the DL850.	1. DL850 initialization. 2. Irregular message mnemonic. Red: Not recognized.	1. Cycle DL850 power / do a “factory reset” after NMEA connection is established. 2. Check remote (talker) setup.
NMEA output signals are not accepted by the remote system.	1. Remote (listener) setup.	1. Verify correct remote (listener) setup.
Analogue output malfunctions.	1. Incorrect range settings.	1. Verify upper and lower limits in status screen.
Pulse output malfunctions.	1. Incorrect pulse frequency settings.	1. Verify pulse settings in status screen.
Basic functionality		
Constantly wrong speeds or no speed.	1. Wrong calibration. 2. Damaged sensor.	1. Check calibration/re calibrate. 2. Replace sensor.
No bottom tracking.	1. Too deep water (> 150 m).	1. See specifications for depth range, “Performance” on page 67.
Bottom tracking is intermittent or erroneous.	1. Marginal gain or power settings. 2. Weather conditions. 3. Transducer installation faulty.	1. Adjust settings. 2. Try adjusting gain and power settings. 3. Check transducer wiring.
No echo gram contour.	1. Echo sounder is switched off.	1. Echo sounder can be switched on in screen Diagnostics menu 3. Note: Not recommended used if other echo sounders are in operation.
Unrealistic aft speed values in docking mode.	1. Wrong setup of ship parameters.	1. Check installation values for over all length and bow to sensor.
No water track, just bottom track.	1. Flashing GPS-BT, too weak signals. 2. Not flashing GPS-BT, sensor failure.	1. Contact manufacturer, if problem persists. 2. Contact manufacturer.

Typical Status Screen Contents

The status screen contain information that will facilitate analysis and correction of several problems. Information from the status and diagnostics screens should be sent by fax/E-mail with any report about functional disturbances.

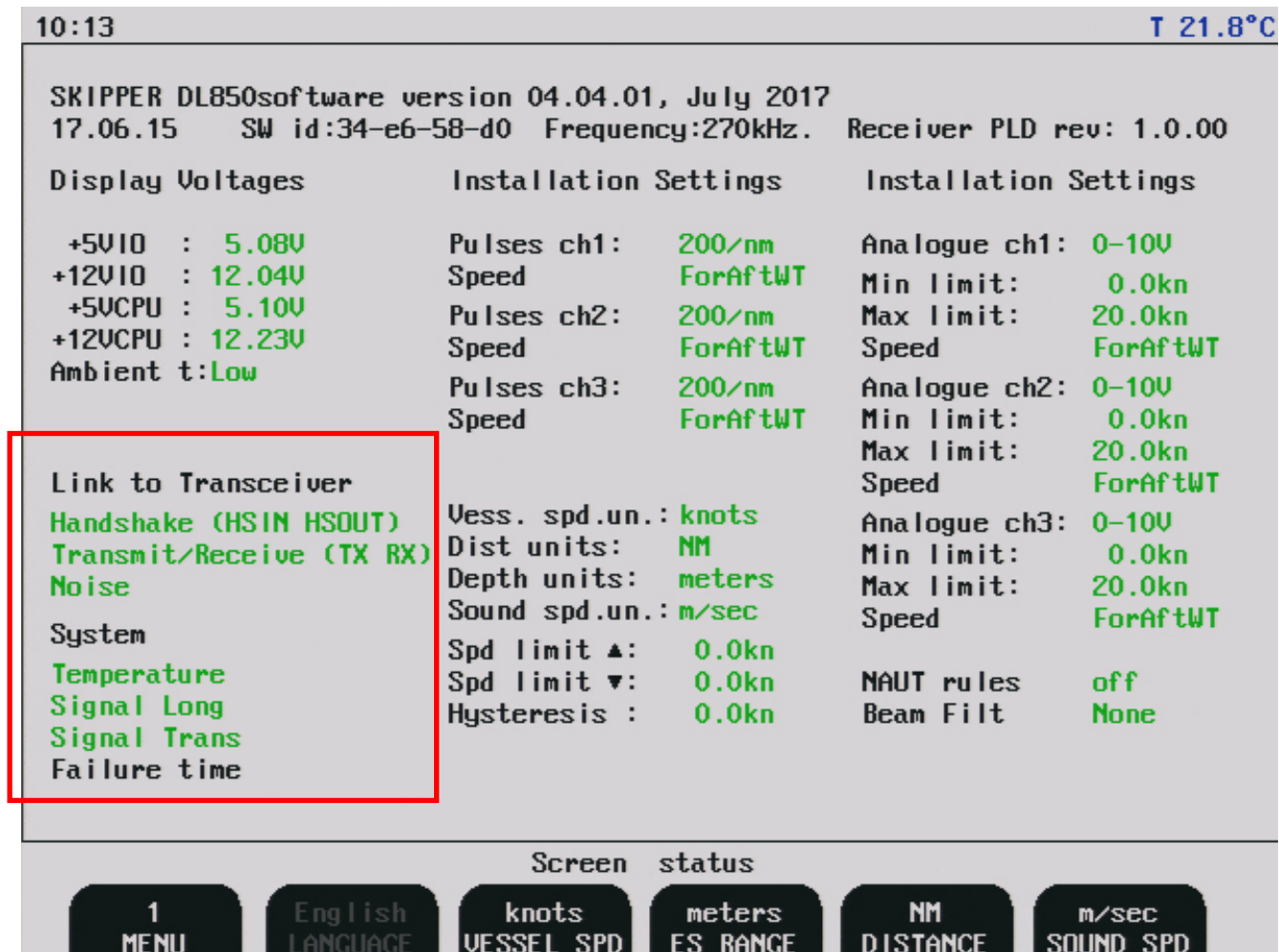

If it is at all possible to cycle through the screens and observe this information, several assumptions may be made regarding operation of the DL850 system. Although some of the subsystems necessary for this basic system operation may still suffer from minor or intermittent operation disorders, the fact that it is possible to select and observe this screen, indicate correct operation of the following DL850 subsystems:

1. The CPU board is operating.
2. The keyboard and backlight PCBs are working.
3. The keyboard interface part of the I/O PCB is working.
4. The power supplies on the terminal board are basically working.

The information in the red box on previous page, shows the quality of the signals.

- **Link to Transceiver;** shows the internal communication status between display unit and transceiver unit. Errors in this usually refer to a failure in cabling between the display unit and transceiver unit, but can also point to a failure inside the transceiver cabinet. (See [“Installation problems” on page 57](#) for more information).
- **Temperature** will indicate a failure on the temperature sensor. This can be an early warning of other problems.
- **Signal Longitudinal & Signal Transversal;** these indicate bad or no results from the sets of longitudinal or transversal beams. This may be caused by system failure or bad acoustic conditions. If the problem persists, the self diagnostics should be used to find out if the system has a problem.

The other information on the status screen is a collection of information which may be observed and manipulated with the various screen softkey selections. As a reference, it will often be more convenient to observe the various settings together on this screen than to cycle from screen to screen to check on the softkey texts.

Screen diagnostics

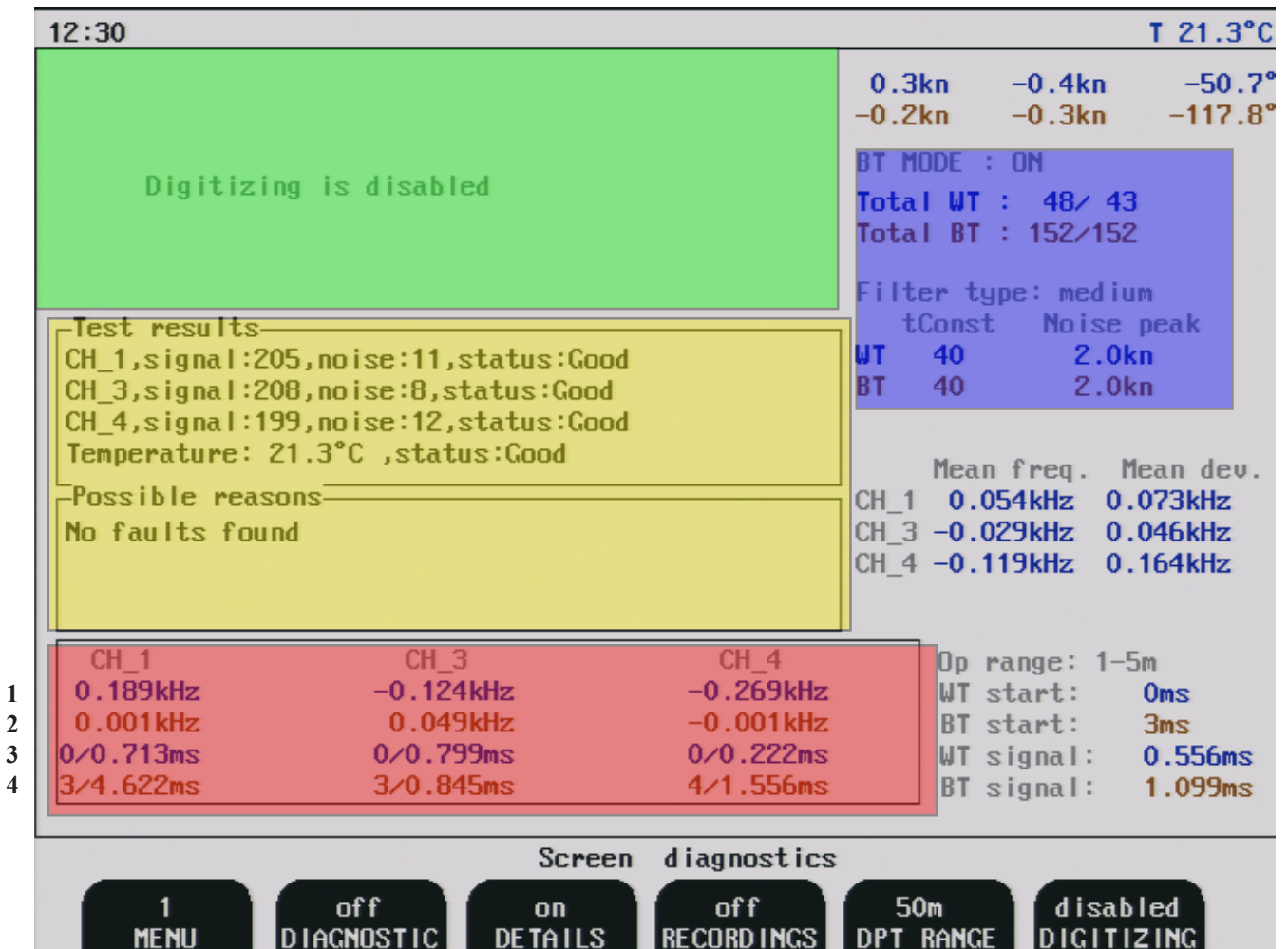

This diagnostic screen is used for self test and diagnostics and recordings of the system

The yellow area. Diagnostic self test results

The red area. The Doppler frequencies and quality parameters

The blue area. Number of pings for an approved speed measurement.

The green area. A digitized scope of the received signal

Diagnostics

A diagnostic test is performed by pressing ‘DIAGNOSTIC’ to ‘on’. The test will take about 40 seconds.

The yellow highlighted section shows the results of the DIAGNOSTIC test. In addition, it will analyse the inputs from other sensors. The results will be shown in the ‘test results’ frame, and advice based on the results will be displayed in the ‘Possible reasons’ frame.

1: Signal level

The sensor will send particular acoustic signals out on all beams and check the level of water track received is within specification. Level above 140 is good.

Too low signal may be caused by several reasons like:

“Missing +9 VOLT to the transducer”

“Missing -9 VOLT to the transducer”

“Damaged transducer element(s)”

“transducer cable is not connected”

“Bad connection of the transducer cable”

2: Sensor noise

The sensor will stop pinging and measure any noise created. A noise level below 24 is good.

This test is included in software version 4.04.01 to identify an oscillation noise that can happen on the DL850 series manufactured before March 2017. (Serial # <17820)

The system will try to interpret the the diagnostics test result in section “Possible reasons”

Failing noise test

A sensor failing the noise test is probably defective and should be replaced.

The screenshot shows a diagnostic test interface with the following data:

- Time: 12 24, Temperature: T 20.5°C
- Signal levels: 3.3kn, -0.6kn, -10.9°, 0.6kn, 0.2kn, 22.5°
- BT MODE: ON
- Total WT: 42/ 41, Total BT: 42/ 41
- Filter type: medium
- tConst: 40, Noise peak: 2.0kn
- Mean freq.: CH_1 0.078kHz, CH_3 -0.094kHz, CH_4 -0.196kHz
- Mean dev.: CH_1 0.063kHz, CH_3 0.040kHz, CH_4 0.043kHz
- Op range: 1-5m, WT start: 0ms, BT start: 4ms, WT signal: 0.802ms, BT signal: 0.948ms
- Test results: CH_1,signal:,noise:160,status:Too high noise; CH_3,signal:,noise:132,status:Too high noise; CH_4,signal:,noise:45,status:Too high noise; Temperature: 20.5°C ,status:Good
- Possible reasons: Too high noise in more than 1 channel. The sensor must be replaced. Signals were not tested - too shallow
- Channel details table:

CH_1	CH_3	CH_4
0.056kHz	-0.076kHz	-0.186kHz
-0.003kHz	-0.007kHz	0.008kHz
0/0.534ms	0/1.377ms	0/0.577ms
4/2.667ms	3/1.067ms	3/0.756ms

If the noise test fails in one channel only (on repeatable diagnostics tests) it is possible to temporarily disable the failing channel.

See Appendix 5 for procedure. The DL850 speed log can work with only 2 channels in operation.

The blue area shows the results of the second stage filters which remove data that varies too far from the standard deviation. The filter type has a tConst (time constant) which is the number of pings used to approve a value (a form of rolling time average filter). If data is noisy from ping to ping then some data will be rejected and the limit is set by the noise peak parameter. The Total WT and Total BT shows how many pings were used to get the present value XX/YY, where XX is longitudinal value and YY is transversal value.

Example: If the FILTER soft key (menu 2) is set to medium (40 tConst, 2 kn noise peak) normal operation will give a total WT of 40 - 45. A noisy system will give maybe 60 - 200. The higher the FILTER, the slower the reaction time of the system. High = Good for stability. Low = Good for dynamic operations. The option run.aver disables the noise peak filter.

The green highlighted section allows the user to observe the return signals from each channel in either water or bottom mode.

The horizontal axis represent time for the sound to travel down and back from an object or water layer. The vessel is located at the left edge of the grid, and the right edge represent the range. The vertical axis represent the magnitude of the received echo signal.

By using the SCOPE button in menu 1, each channel can be selected and detection points as well as noise levels can be observed. The bottom and water pulses should reach close to the top of the scope screen, while the noise should be close to the bottom, (first 2 divisions). Higher than this implies the sensor receiver is malfunctioning or is noisy. The time base (horizontal scale) of this screen can be changed using the DPT RANGE button on menu 1.

The red area. The Doppler frequencies and quality parameters:

Each channel has a set of parameters

1. The first line shows the Doppler shift of the water track signal. The doppler frequency in kHz represent the speed.. When the vessel is moving forward Channel 1 is forward looking and will normally be positive. Channel 2 and 3 will normally be negative
2. The second line shows the Doppler shift of the bottom track signal. Available at depth <150m.
3. The third line shows the waiting time between ping and sampling for the water track, and is fixed in time. The figure after the ” / “ shows the length of the return signal before it fades. This gives an idea of how much signal is reflected from the water particles. If this is very low, the water is very clean or the transmitted signal is weak.
4. The fourth line is as the third, however for the bottom track. The first number will vary with depth, and from these numbers you can get an idea of the slope of the bottom. It will also show if the bottom track is triggering from something other than the bottom (for example a fresh water layer or fish). The figure after the “ / “ shows the width of the bottom reflection. This will typically be longer than the transmitted ping and will get longer on sloping bottoms.

Possible Failures

When a failure occurs with the system, this screen allows the user to perform diagnostics. A failure in the transceiver or sensor will be observable on this screen. Typically as follows:

1. Single channel failure: A single channel shows ”????” (question marks) in all frequency fields. This can be a failure in the sensor head or in an individual channel on the transmitter. Check the scope (green area) on the relevant channel.

Channel 1 = Fwd

Channel 3 = Starboard

Channel 4 = Port

If one channel is noisy, the sensor element is probably defective. To ensure the failure is the sensor and not the transceiver, swap the transducer channels inside the transceiver cabinet on receiver connector J502. For example if the suspected error is on channel 3, swap channel 1 and 3. Repeat this procedure on transmitter connector J503. (See [“270 kHz Sensor Cable Connection” on page 75](#) for details).

Note: Remember to turn off power at mains before attempting this!

The result of this will probably be that the “????” (question marks) will move to the new channel. This confirms that the fault is in the sensor or cable. If it does not move, the fault is within the transceiver cabinet (either transmitter or power card).

Take 3-4 pictures of the screen with a few seconds interval and send by E-mail to manufacturer.

2. All channels “????” and below (question marks) in red area.

If all channels are ????, the fault is most likely the power supply to the sensor. Check all terminals on J502 and J503 are fastened securely and correctly. (See [“270 kHz Sensor Cable Connection” on page 75](#) for details).

If the temperature is also wrong (e.g. -4) the problem is most likely the sensor power supply. Measure the + - 9V power supply to the sensor (pins J502 p 20 - 21 and 23 - 21) with and without the sensor wires attached. If the voltage drops considerably with the sensor power attached, the sensor is most likely faulty, although the power card is also suspected. If the problem is not identified here, refer to further instructions available as a data bulletin on the SKIPPER web site.

Recording of sensor data:

Since the system status definition is based on the statistical experimental results (not direct measurements of the parameters), the conclusions may be somewhat subjective. Therefore, it is advisable for the service personnel to use alternative validation methods before replacing the transducer. Such method is “recordings” in “Screen diagnostics”. This recording will store the received signals to the internal “compact flash memory card”. At a time of error press “recordings” to on. Make the recording for about 1 - 2 hours. Then set back to “recordings off”

Open Display unit door. Switch off main power.



Take out Compact Flash (CF) memory card. Insert it into a PC CF card reader.

Goto folder DL_REC

File Name	Modified	Type	Size
<input checked="" type="checkbox"/> DL_REC	30/01/2017 20:49	File folder	
<input type="checkbox"/> 040303.850	04/08/2008 02:57	850 File	194 KB
<input type="checkbox"/> BOOTLOAD	04/08/2008 02:57	Application	9 KB
<input type="checkbox"/> HIMEM.SYS	04/08/2008 02:56	System file	33 KB
<input type="checkbox"/> SMARTDRV	04/08/2008 02:56	Application	44 KB
<input type="checkbox"/> STARTUP	04/08/2008 02:56	Application	182 KB

In this folder copy the recorded file with todays date

Send by mail to support@skipper.no together with a photo of “Screen status” and “Screen diagnostics”.

Reset factory procedure.

In some cases the display cabinet may get “confused”, or the user has “adjusted” too much. Performing a “reset factory” procedure will return all values to factory default settings.

The “Reset factory” will not reset calibration, I/O settings (NMEA) or total trip.

- To perform “reset factory”, See [“RESET FACTORY”](#) on page 26

Master reset procedure.

If “reset factory” did not help performing a master reset procedure will return all values to factory default settings.

Important note: Before performing this, note your calibration settings, and setup for inputs and outputs as these will be lost during this procedure.

- Switch off the display unit using the internal toggle switch(es) and wait a few seconds.
- Then press down and keep pressed the softkey to the far right and far left (no. 1 and 6) in the upper row on the keyboard (softkeys).
- Turn “on” the display unit, and keep the two softkeys pressed down until the screen shows the normal picture. This may take as long as app. 30 seconds.
- You should now normally hear 4 “beeps”.

Note: You will now have to re-apply your settings for calibration, input/output and screen settings

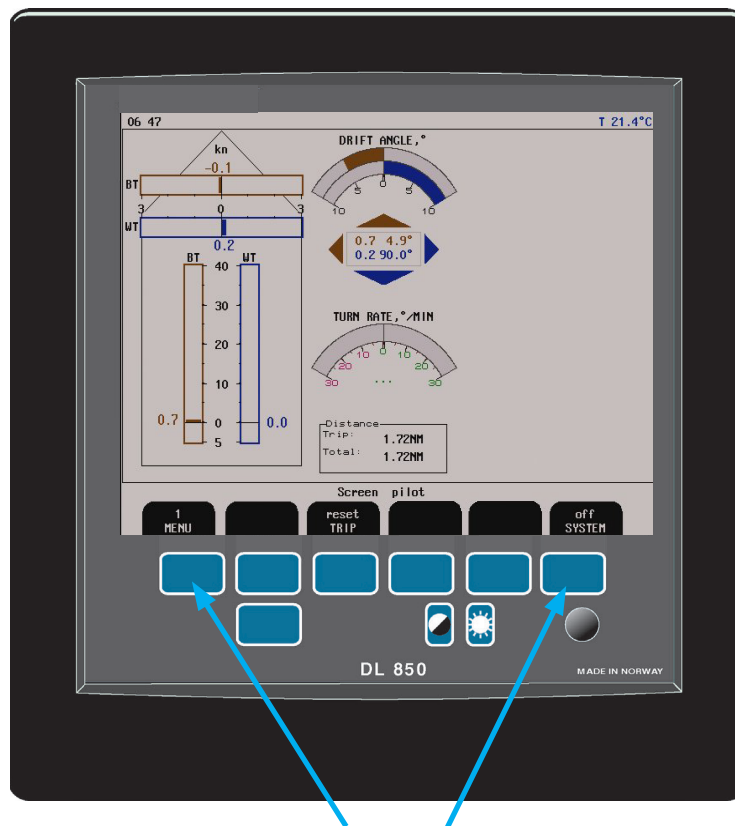

Master reset: Press down these two softkeys and keep them pressed during the “power-up” sequence.

7. Specifications

Dimensions

Transducer, 3 beam 3 x 270 kHz	D x H	99 x 115 mm.
.	Mounting	Sea valve/tank/retrofit.
	Cable length	40 m.
	Weight	app. 10 kg (w/cable).
Transceiver cabinet	H x W x L	450 x 300 x 260 mm.
	Weight	app. 15 kg.
Operator unit cabinet	Height, front	340 mm.
	Width	320 mm.
	Depth	170 mm.
	Weight	app. 10 kg.
Operator unit cabinet		
	Cut-out for flush mounting	H x W: 324 x 304 mm.
	Corner radius	4 mm.

Functional Properties

Display	<ul style="list-style-type: none"> 150 x 200 mm (10.4 inch) LCD with adjustable backlight, 640 x 480 pixels.
Supply voltage	<ul style="list-style-type: none"> 115/230 V AC. 24 V DC (20-32 V)
Power consumption operator unit	<ul style="list-style-type: none"> 50 W at 24 V DC. 70 W at 115/230 V AC.
Speed alarms	<ul style="list-style-type: none"> High and low limits.
Calendar/clock	<ul style="list-style-type: none"> Year-month-day/hours-minutes-seconds (24 hour system).
Interface outputs	<ul style="list-style-type: none"> 10/100/200/400/1000 pulses per nautical mile. Analogue 4 - 20 mA and 0 - 10 V. IEC 61162-1:2007(E) (NMEA 0183) (RS-422). Alarm relay change-over contact, max. 24 V 300 mA. Output for VGA repeater.
Interface inputs	<ul style="list-style-type: none"> IEC 61162-1:2007(E) (NMEA 0183) (RS-422).
Languages	<ul style="list-style-type: none"> English.
Options	<ul style="list-style-type: none"> IR300 digital speed repeater. CD401 LR digital speed repeater.
Protection	<ul style="list-style-type: none"> IP 22

Performance

Speed range	+/- 40 knots, (under favourable installation and sea conditions up to +/- 50 knots).
Depth range for water track	> 1.5 m.
Maximum roll angle	+/- 10 degrees.
Maximum pitch angle	+/- 5 degrees.
Depth range for bottom track	2 - 150 m.
Digital resolution	0.1 knots.
Digital screen resolution	<10 m: 0.01 m.
	>=10 m < 100 m: 0.1 m.
	>=100 m: 1 m.
Speed and distance accuracy	0.2 knots or 2 %, whichever is greater.
Measuring accuracy	Better than 1 %

Note: The performance widely depends on the hydro acoustic properties of the water column (aeration turbulence, depth, etc.), bottom conditions (sea-bed material, steepness of topography) and vessels rolling and pitching. These effects can lead to occasional failure of the system or to incorrect indication of speed and distance (unstable or too low values).

Note: The stated data for depth ranges and accuracy are not valid for unfavourable conditions. Since the speed accuracy depends on the sound speed (affected by salinity and water temperature), it is important to adjust (manually) this parameter for particular operation area, (see [“Screen calibration, Menu 3, mounting settings.”](#) on page 29 for details).

Environmental

Transducer and transceiver cabinet

Operating temperature	-15 - 55°C.
Storage temperature	-20 - 70°C.
Protection, transducer	6 bar IP 68.
Protection, parts inside hull	IP 56.
Protection transceiver cabinet	IP 42.

Operator unit cabinet

Operating temperature	-15 - 55°C.
Storage temperature	-20 - 70°C.
Humidity	10 - 90 % relative, no condensation.

8. Service

- All service requests should be made to the local provider or representative. Contact details on title page.
- Adjustments and repairs should only be performed by qualified service engineers.
- Unqualified repair attempts will void the warranty.

Additional diagnostics aids can be provided by your local representative or by the manufacturer (contact details on title page). If service is required, please ensure the service centre is given:

- Serial and part number(s) of all affected parts.
- If possible, photos of screen Calibration, screen Status and screen Diagnostics.
- Sensor mounting type, (tank or sea valve).
- Vessel name.
- Problem description.
- Contact information for vessel bridge.

10. Appendix 1

Miscellaneous Installation Diagrams

Following diagrams, drawings and pictures are included:

- Fig. 10.1. Picture of transceiver unit showing PCB positions. See [“PCB positions in Transceiver Unit” on page 71.](#)
- Fig. 10.2. LEDs on PCBs in the transceiver unit. See [“LEDs on PCBs in Transceiver Unit” on page 72.](#)
- Fig. 10.3. System overview. See [“DL 850 System Overview” on page 73.](#)
- Fig. 10.4. Interconnection diagram between the operator unit and the transceiver unit. See [“Operator Unit - Transceiver Unit Interconnection” on page 74.](#)
- Fig. 10.5. Interconnection diagram between sensor and the transceiver unit. See [“270 kHz Sensor Cable Connection” on page 75.](#)
- Fig. 10.6. Dimensional drawing of transceiver unit. See [“Transceiver Unit Dimensions” on page 77.](#)
- Fig. 10.7. Dimensional drawing of operator unit. See [“Dimensional Drawing Cabinet” on page 78.](#)
- Fig. 10.8. 115/230 V selection on backplane inside Transceiver Unit. See [“115/230 V selection on backplane inside Transceiver Unit” on page 79.](#)

For bottom part installation, there are separate manuals. All manuals (examples below) available on manufacturers homepage. (See title page for details).

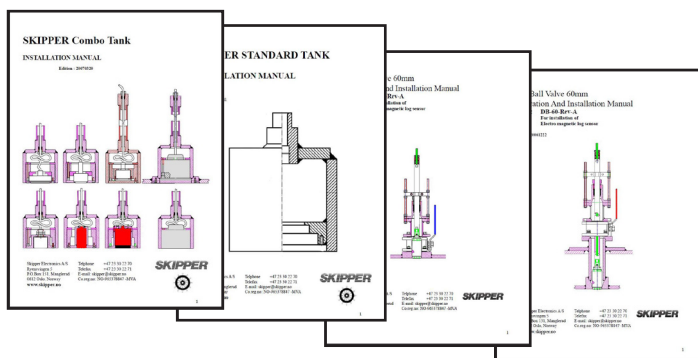

PCB positions in Transceiver Unit

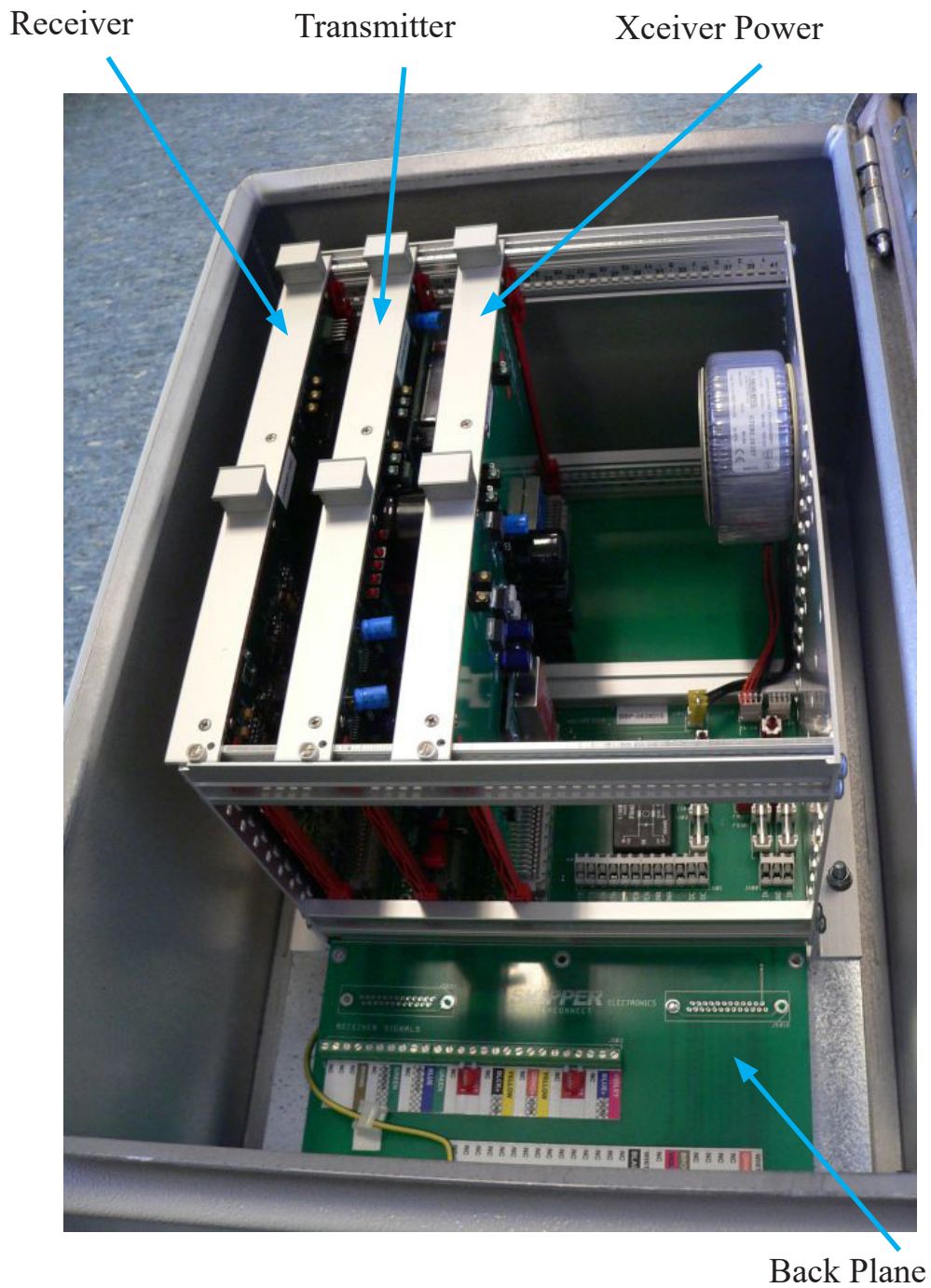
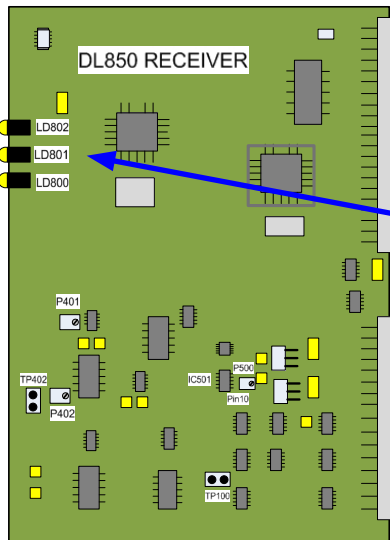

Fig. 10.1 PCB positions in Transceiver Unit

LEDs on PCBs in Transceiver Unit



LEDs on Receiver Board

- LD 802: CPU Reset
- LD 801: Transmit Data
- LD 800: Program Download

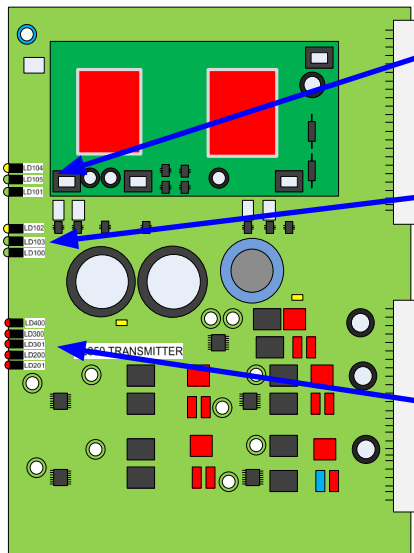

LEDs on Transmitter Board

- LD104: Echo Sounder 100 % Power
- LD105: Echo Sounder 25 % Power
- LD101: Echo Sounder Power active
- LD102: Speed Log 100 % Power
- LD103: Speed Log 25 % Power
- LD100: Speed Log Power active
- LD400: Ch 5 active } Channel 5:
270: Not Used (GND)
540: ES (Echosounder)
- LD300: Ch 3 active } Channel 3:
270: Strb Aft
540: Strb
- LD301: Ch 4 active } Channel 4:
270: Port Aft
540: Port
- LD200: Ch 1 active } Channel 1:
270: Fore
540: Fore
- LD201: Ch 2 active } Channel 2:
270: Not Used (GND)
540: Aft

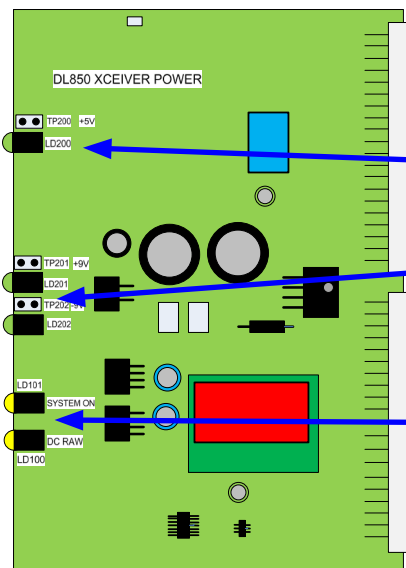

LEDs on Power Board

- LD 200: +5V
- LD201: +9V
- LD202: -9V
- LD101: System On
- LD100: DC Raw

Fig. 10.2 LEDs on PCBs in Transceiver Unit

DL 850 System Overview

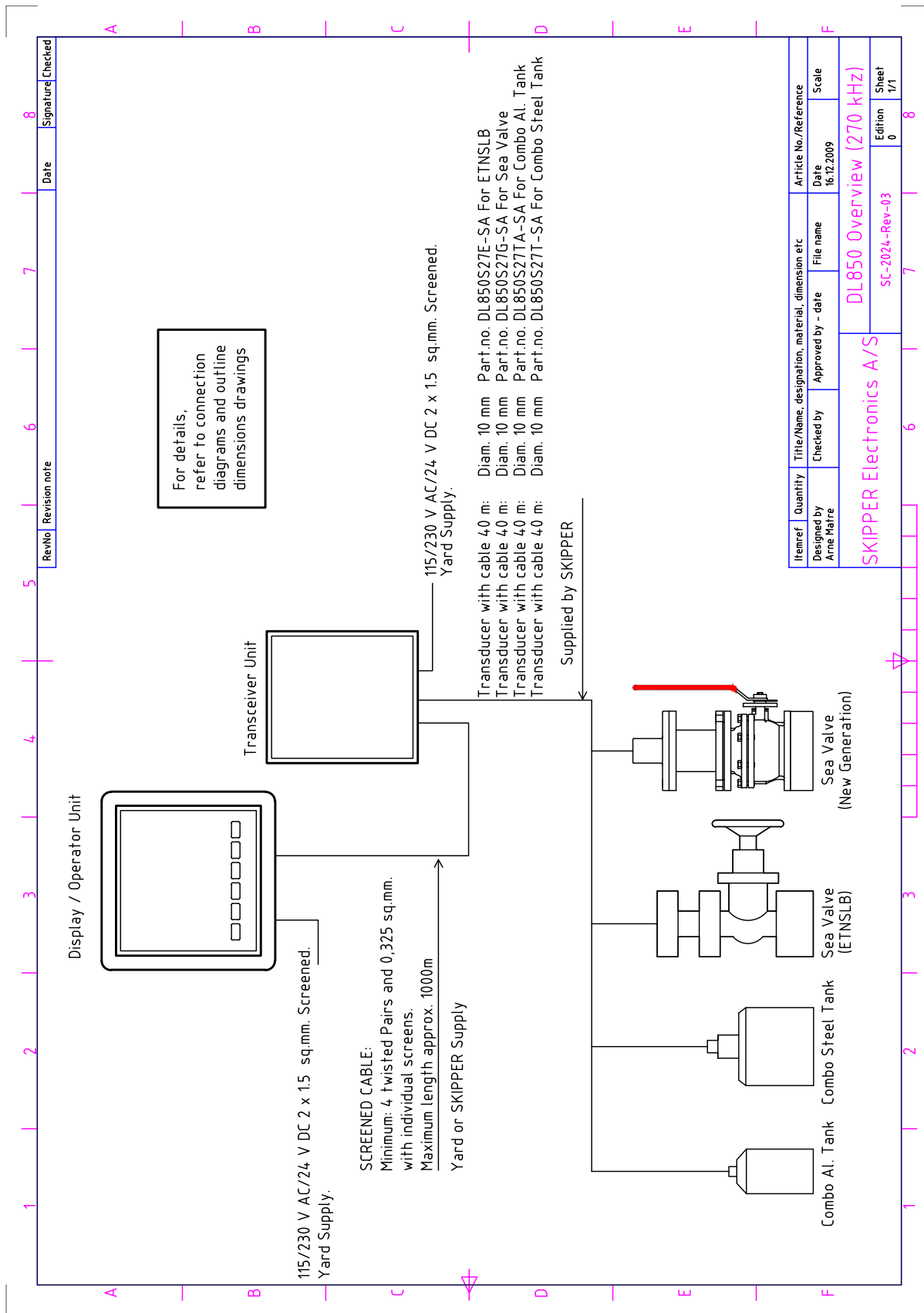

Fig. 10.3. System overview

Operator Unit - Transceiver Unit Interconnection

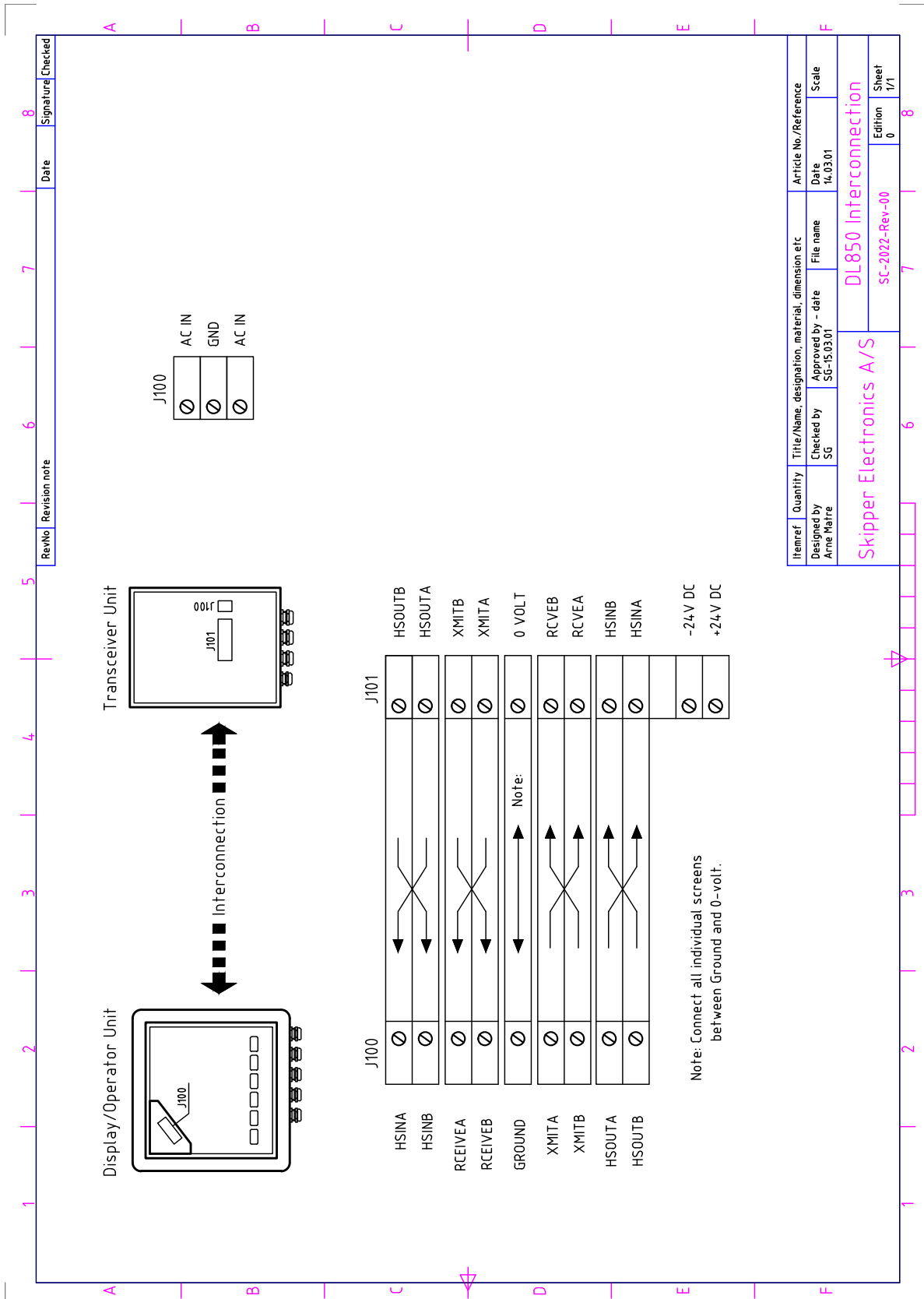

Fig. 10.4. Transceiver unit - operator unit interconnection

Ferrite on AC power input

The transceiver unit is supplied with a ferrite EMC kit to be mounted on the AC power cable. The supplied ferrite has an inner diameter of 9mm.

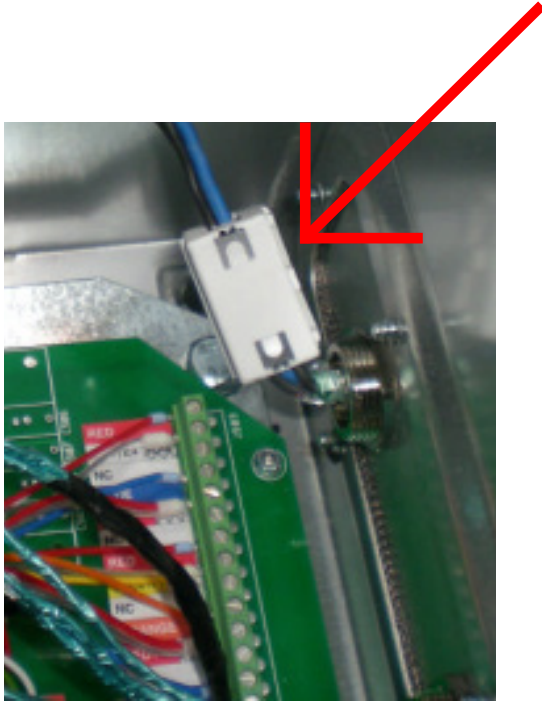

Fig. 10.5.1 Transceiver Unit EMC kit

Transceiver Unit Dimensions

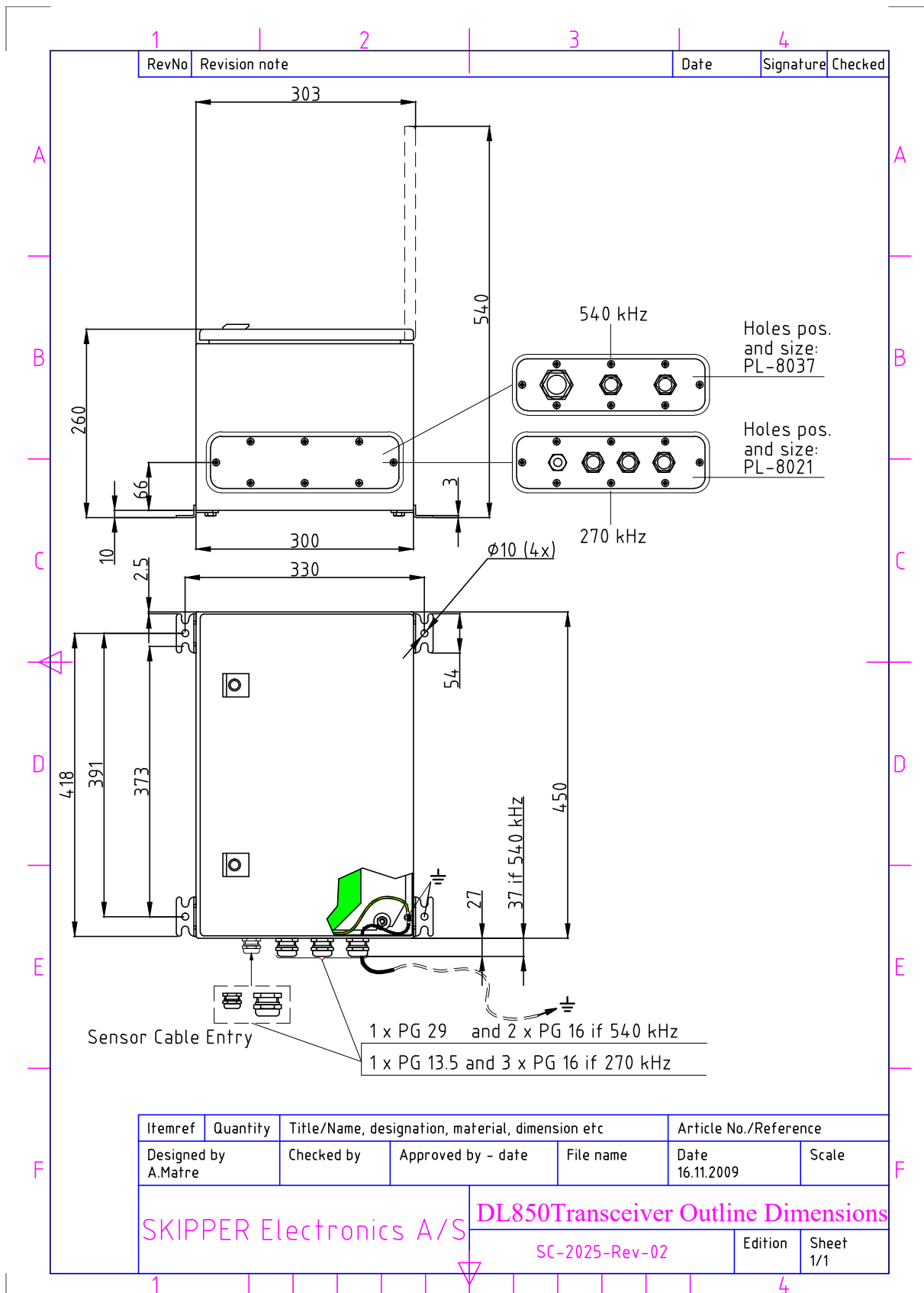

Fig. 10.6. Transceiver Unit Dimensions

Dimensional Drawing Cabinet

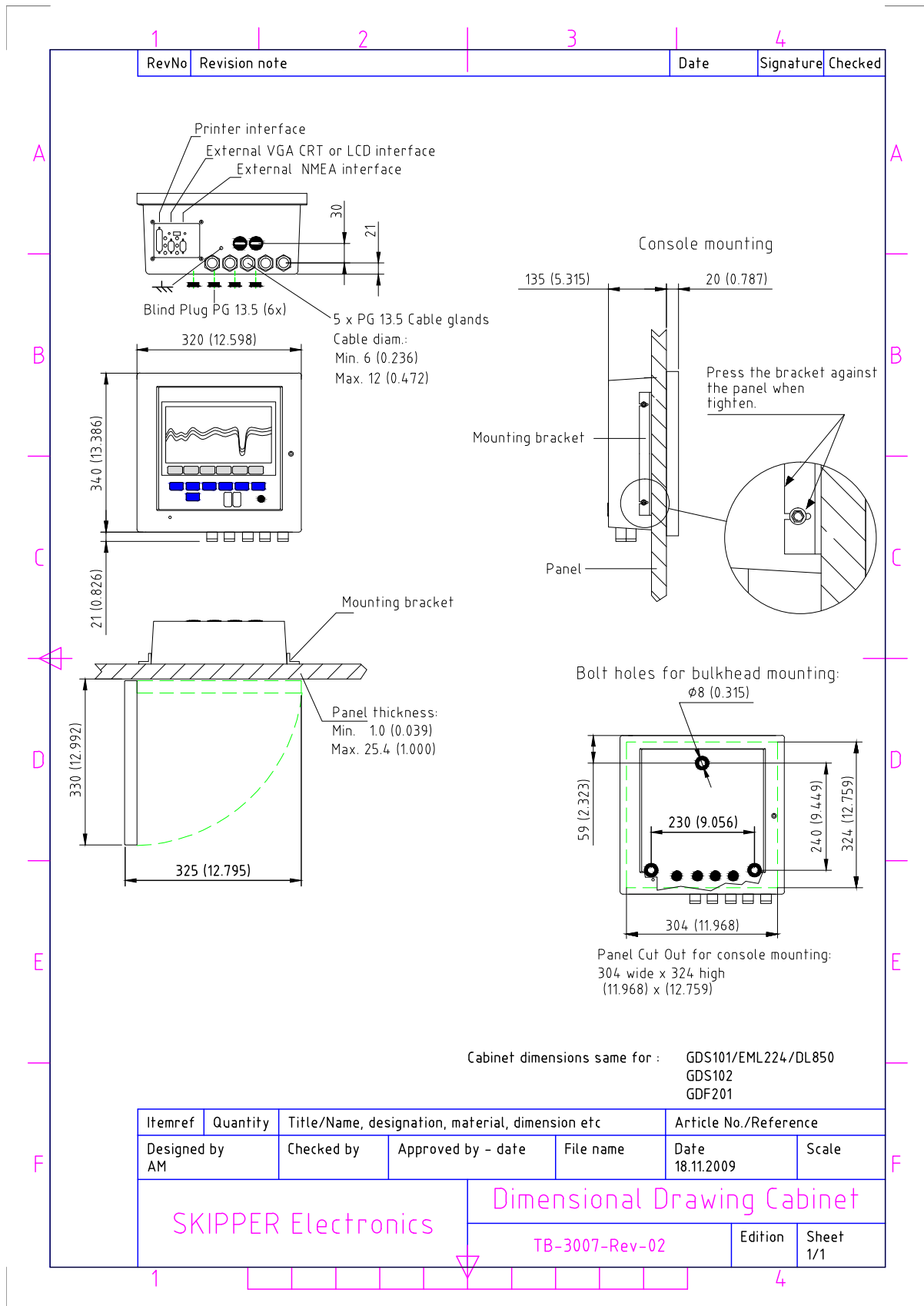

Fig. 10.7. Cabinet Dimensions

115/230 V selection on backplane inside Transceiver Unit

If the AC power system is 115 V, the Transceiver unit may be prepared for 115 V AC by re-connecting the connectors J102, J103 as shown in figure 10.8.

This figure also shows position of fuses for 115/230 V AC and 24 V DC. These fuses are normal 5 x 20 mm glass fuses.

- AC supply:** FS100, FS101 230 V 0.5 A slow blow. (Standard)
 115 V 1 A slow blow. (**Note: Not included**)
- DC supply:** FS102 24 V 3.15 A slow blow. (Standard)

When the installation is complete, and power is connected to the Transceiver unit, the appropriate power switch by the power terminals is switched on. Both 115/230 V AC and 24 V DC power may be connected and switched on at the same time. If one of these supplies shuts down, changeover is automatic.

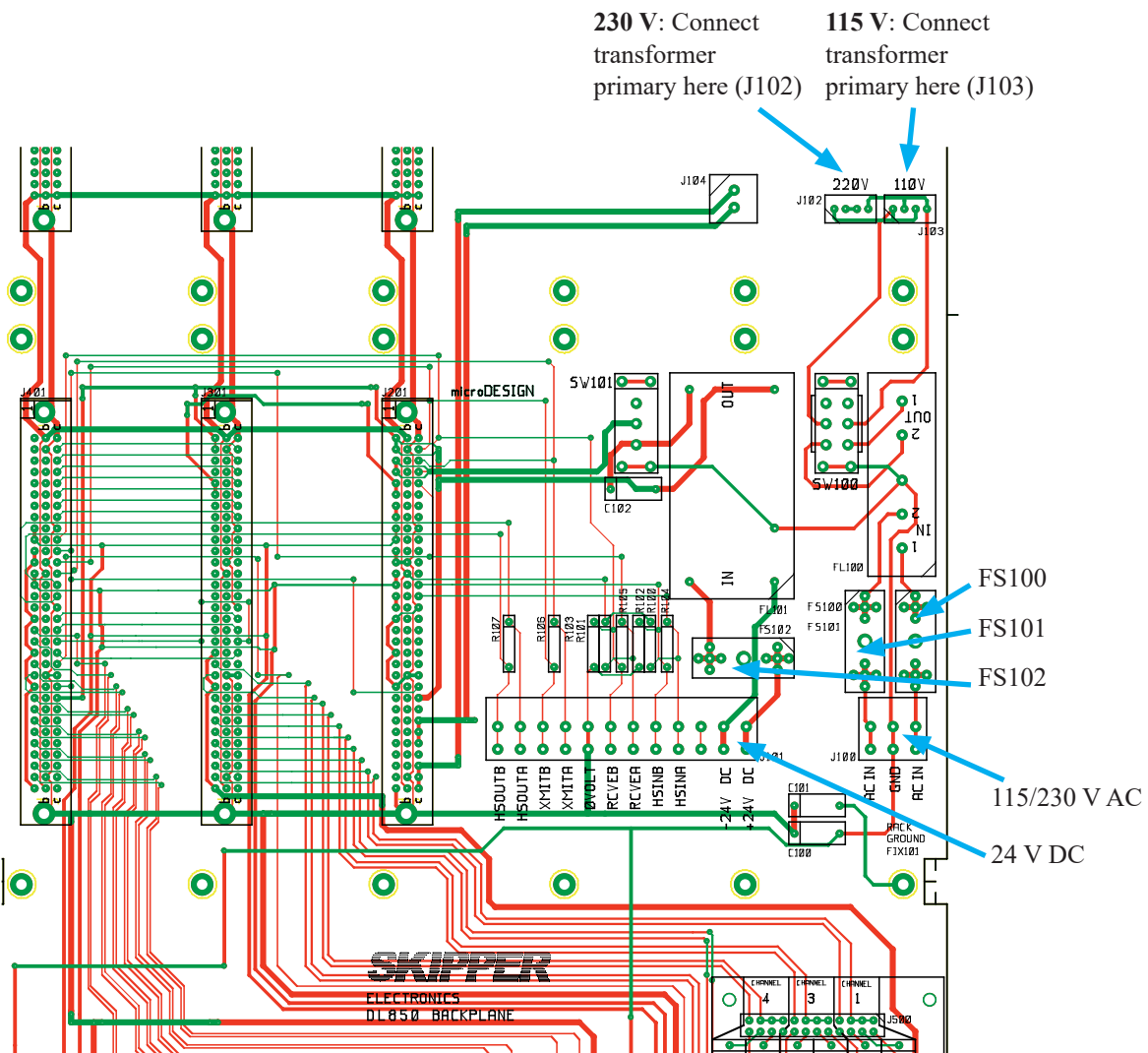

Fig. 10.8. 115/230 V selection on Transceiver unit backplane

11. Appendix 2

Upgrading Software

New software versions are released from time to time. The DL850 with Compact Flash (CF) can be updated by performing the following software upgrade procedure.

1. If you have received a programmed compact flash, skip stage 2.
2. Newest software may be downloaded from the web <http://www.skipper-service.no/skipdoc/skipdoc.php>. Under “software” you will find your equipment type. Also copy the latest version of startup.exe into the root folder..

Note: Standard Compact Flash reader is needed to be attached to the PC.

Note: It is possible to use the Compact Flash card, which is already installed in the display unit.

3. Switch OFF the mains of the display unit and insert Compact Flash card with the new software on it.
4. Press the “hidden” button inside the cabinet (mounted on the solder side of the keyboard). Keeping the hidden button pressed, switch ON the mains in the display unit and keep the button pressed while the message “You may release the upgrade button” appears in the lower part of the screen. If a new setup.exe is to be loaded, follow the on screen instructions.
5. Release the hidden button. After few diagnostic text messages, the list of available software versions will appear in the lower part of the screen as in example below.
6. Note: If the bootloader does not find any file with the software on the Compact Flash, the presently installed version will start automatically. In this case, make sure, that the upgrade and setup file has been copied correctly on the Compact Flash and repeat procedure.

4.03.03	4.04.01				
Active	External	KEY 1	KEY 2	KEY 3	KEY 4
		KEY 5	KEY 6		

7. Select a software version, which you would like to install. Normally, it is possible to chose one out of two: the version, which is currently installed in the internal memory (indicated as Active) and the upgrade version (indicated as External). The version name is displayed in the upper line of the text lines, located just above the corresponding softkey. In the example above, soft key #2 should be pressed to select the latest software version.
8. Confirm selection by pressing YES button (or go back to selection, pressing NO).
9. Press any button to start the upgraded software (or it will start automatically in 5 seconds).
10. Note: The file with a previous software version will be copied back to the Compact Flash card, so it would be possible to re-install it in the similar manner, if desired.

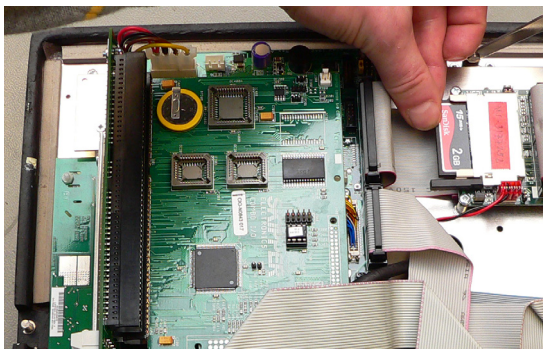

Upgrading software (summary):

- Insert CF with new software in external MESA board.
- Switch “On” mains inside display unit while pressing “hidden button” on rear side of keyboard.
- Follow instructions on screen.

CPU PCA-6742VE setup

- Connect a PC keyboard and a VGA screen to the CPU board.
- Switch “On” the unit while pressing “Delete” key on the PC keyboard.
- Do not release the “Delete” key before the “Setup” picture is present on the screen.

(Bios version 1.12). The PCA 6742 has the default settings with the following changes. Start by loading the optimized defaults, and then change the following:

Standard CMOS FEatures

Date: Change to todays date

Time: Change to time now

Halt on: No errors

Advanced BIOS Features

- a. Hard Disk priority [Press enter] – Press enter
 - i. 1 should be ch.1 M.
 - ii.2 should be ch 0 M.
- b. First Boot Device[Hard Disk]
- c. Second Boot Device [Hard Disk]
- d. Boot other device [Disabled]

Advanced Chipset features

- a. SMI712 VGA Settings [Press Enter] – Press enter
 - i. SMI712 VGA Monitor [Simul monitor]
 - ii.Panel resolution Mode [640x480 TFT]
- b. USB Device Setting [Press Enter] – press enter
 - i. USB1.0 emulation [Disabled]

Integral Peripherals

- a. Onboard serial Port 3 [enter]
 - i. Change to [2E8/IRQ9]
- b. Onboard serial Port 4 [enter]
 - i. Change to [3E8/IRQ5]
- c. Parallel Port Mode [EPP]
- d. EPP Mode Select [EPP1.9]

PnP/PCI Configurations

- a. Resources Controlled By [Manual]
- b. IRQ Resources [Enter]
 - i. IRQ – 7 assigned to [Legacy ISA]
 - ii.IRQ – 10 assigned to [Legacy ISA]
 - iii.IRQ – 11 assigned to [Legacy ISA]
- c. NO DMA

PC Health Status

- a. Case Open Warning [Disabled]

SAVE SETTINGS AND EXIT

12. Appendix 3. Non wheelmark approved features

In this appendix we will describe the functions only enabled after 3 beeps (about 12sec) pressing the hidden key. These features are non-approved features.

Echo sounder function

The echo sounder (ES) function on “screen Pilot” is disabled by default, and the control softkey (ES MODE) on “screen Diagnostics”, “menu 3” is not available.

To enable the ES MODE soft key 3 (“screen Diagnostic, menu 3”), first set the DETAILS soft key 2 in screen Diagnostics menu 1 to “On”, then press the “hidden button” (inside the cabinet) and keep it pressed for about 12 seconds (third beep must be heard while pressed). Now, the ES MODE soft key 3 in “screen Diagnostics, menu 3” is visible. Default soft key 3 value is “Off”, set to “On for activation of ES MODE. If the same procedure is repeated once more, the ES softkey 3 will not be visible again. In this case the echo sounder presentation will also be removed from the screen.

Note: The ES function must be disabled on screen diagnostics menu 3 before disabling the buttons.

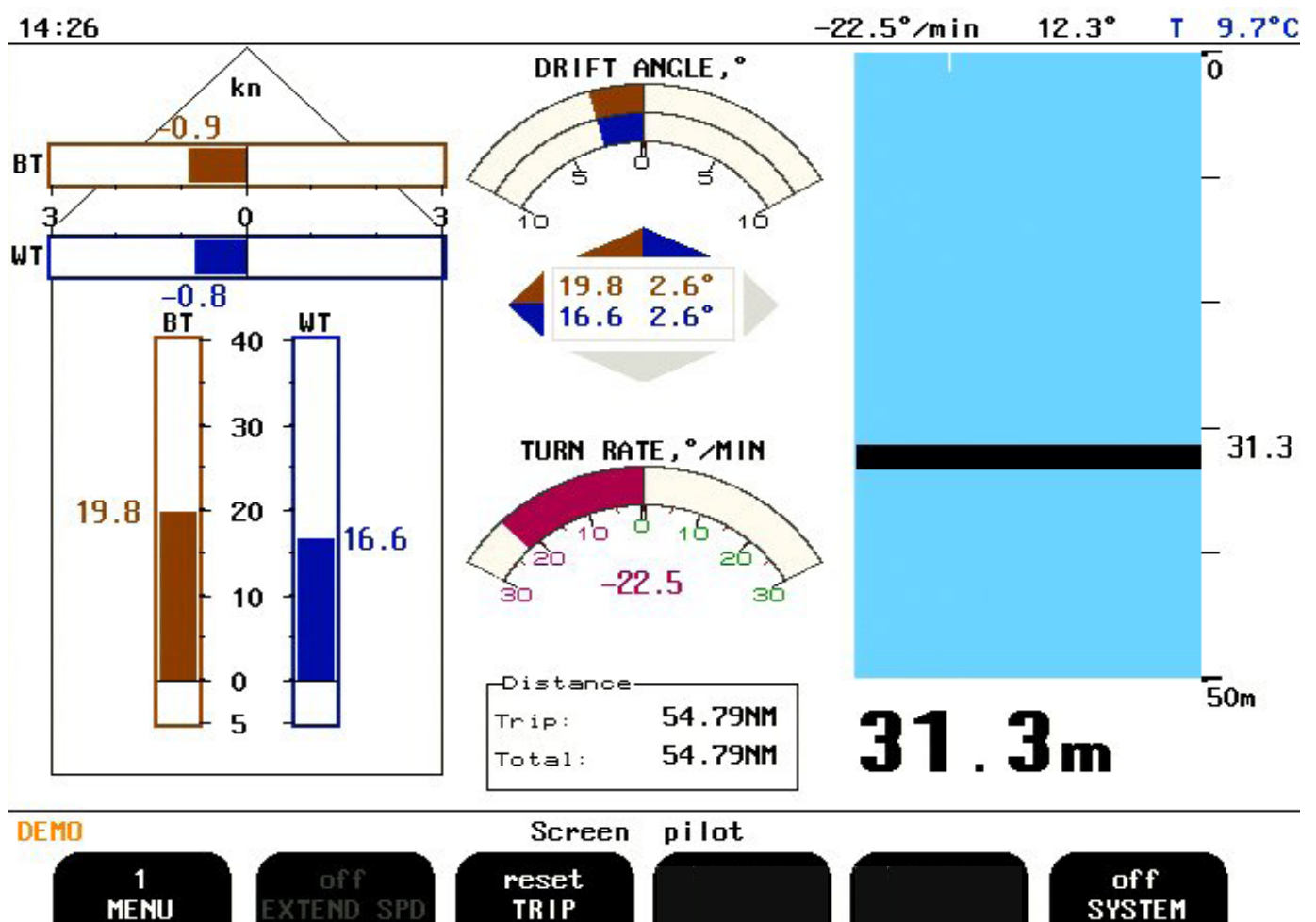

ES MODE active in “screen Pilot

GPS:BT

This softkey allows the user to substitute longitudinal BT value with GPS data if bottom track is lost. The transversal value will be fixed to 0 knots.

A warning “GPS:BT” will flash when Bottom track is from GPS.



Screen Diagnostics, Menu 3.

Softkey	Name	Range/ value	Default value	Description	Activate with hidden button
1	MENU	1 - 3	3	Menu 3 is selected. Note: Use encoder to get access to menu 3.	
2	MEAN VALUE	WT/BT	WT	In “Screen diagnostics” the mean values may be switched to BT values.	
3	ES MODE	On/off	Off	Turn ES mode on/off.	Yes (3 beeps)
4	SL BT MODE	On/off	On	Enabling/Disabling individual BT samples, which are only executed, when the operating range is 25 m or lower. Can be used for trouble shooting and factory testing. Must be switched on at normal operation.	Active when AUTO BT is off.
5	AUTO BT	On/off	On	Toggle automatic bottom track. If switched on, bottom track sampling rate is automatically reduced if the present water depth is greater than bottom track operating range. If AUTO BT is switched off, bottom track function will operate continuously, but still only give BT speed indications within the range for bottom track.	Yes (2 beeps)
6	GPS->BT	On/off	Off	This softkey allows the user to substitute longitudinal BT value with GPS data if bottom track is lost. The transversal value will be fixed to 0 knots.	Yes (3 beeps)

13. Appendix 4. Non wheelmark approved S version

S-version of operator unit

The standard operator unit is a wheelmark approved navigational speed log.

Some customers needs blanking of transmission signals. Use of this is not permitted in Wheelmark products. An operator unit with “special” non-wheelmark software is available. This unit has a different part number and is not wheelmarked.

Control input – PULSE2/Pulse Ref on the terminals.

Max response latency 175us. The 2-byte command needs to be sent from the display to the transceiver. The baud rate is 115200. Interrupt latency is approximately 3us.

Softkey BLANKING is implemented at Screen status, menu 3, which selects the polarity of the blank input signal and mode of operation (TX blank enable/disable).

If BLANKING is set to “high”, the high level on the input will silent the transceiver. Alternatively, the low level on the input will stop transmission if the setting is “low”.

When in TX silent mode, the label “BLANK” is blinking, indicating the silent status. The product name is changed to DL850S on the status screen (upper line).

14. Appendix 5. Experimental features

This Appendix covers some experimental features. The features are accessed by the “hidden button”.

“Screen diagnostics” “Menu 4” (NMEA-Raw, Current, Long samples and Beam filter)

“Screen Calibration”, “Menu 4” (Transducer type)

“Screen Status” “Menu 7” (NAUT rules)



Screen diagnostics, Menu 4, Experimental functions

Soft-key	Name	Range/value	Default value	Description	Activate with hidden button
1	MENU	1 - 4	1		
2	NMEA RAW	On/off	Off		Yes (3 beeps)
3	CURRENT	On/off	Off	Measure current in water from from difference of STW and SOG (This function is ein prototype stadium)	Yes (3 beeps)
4	LONG SAMPL	On/Off	Off	Off: Bottom track measured to 150m On: Bottom track measured to 200m	Yes (3 beeps)
5					
6	BEAM FILT	None/1/2/3	None	None: All 3 Channels in use. 1/2/3: Chosen channel is not in use. The Speed log operates on 2 channels	Yes (2 beeps)

NMEA-Raw

Name	Description	Example
PSKPRAW1	Speed log RAW data	\$PSKPRAW1,A,B,C,D,E,F,G,H,I,J,K *hh
PSKPRAW2	Speed log RAW data	\$PSKPRAW2, L,M,N,O,P,Q,R,S,T*hh

Proprietary NMEA raw data message PSKPRAW1 /2 activated from com screen when the function is activated on 3 beeps in “Screen Diagnostics”, “Menu 4”

Note: Quality parameter is expressed as the ratio of the transmitted pulse length to the received echo length.

\$PSKPRAW1,A,B,C,D,E,F,G,H,I,J,K *hh

- A. TX Frequency (270)
- B. WT Doppler Shift Frequency ch. 1,
- C. WT Doppler Shift Frequency ch. 3
- D. WT Doppler Shift Frequency ch. 4
- E. BT Doppler Shift Frequency ch. 1
- F. BT Doppler Shift Frequency ch.3
- G. BT Doppler Shift Frequency ch. 4
- H. WT longitudinal speed. (instantaneous)
- I. WT tra. (instantaneous)
- J. BT long. (instantaneous)
- K. BT tra. (instantaneous)

\$PSKPRAW2, L,M,N,O,P,Q,R,S,T*hh

- L. depth. (ms) ch1
- M. depth (ms) ch3
- N. depth (ms) ch4
- O. WT Quality ch1,
- P. WT Quality ch3,
- Q. Q WT Quality ch4
- R. BT Quality ch1,
- S. BT Q Quality ch3,
- T. BT Q Quality ch4

Current function

The current in water may be calculated by the difference of STW (Speed through water) and SOG (Speed over ground).

Please note! The current calculation is very depending on an exact sensor heading offset and speed calibration.

To switch on current function:go to “Screen diagnostics#, “Menu 4”

The current function is visible by pressing “hidden button”and keep it pressed for about 12 seconds (third beep must be heard while pressed).

Set “Current ON”

CH_1	CH_3	CH_4	Op range: 1-5m
0.141kHz	0.034kHz	0.074kHz	WT start: 0ms
0.090kHz	-0.058kHz	????	BT start: 3ms
0/1.068ms	0/0.756ms	0/1.201ms	WT signal: 0.919ms
3/1.602ms	3/0.444ms	3/0.000ms	BT signal: 0.314ms



In “Screen pilot”, “Menu2” set “Sea current” to “Auto” The calculation of current will then be automatically switch to SOG from GPS when bottom is lost.

Sea current will be graphically visible in “Screen pilot”.

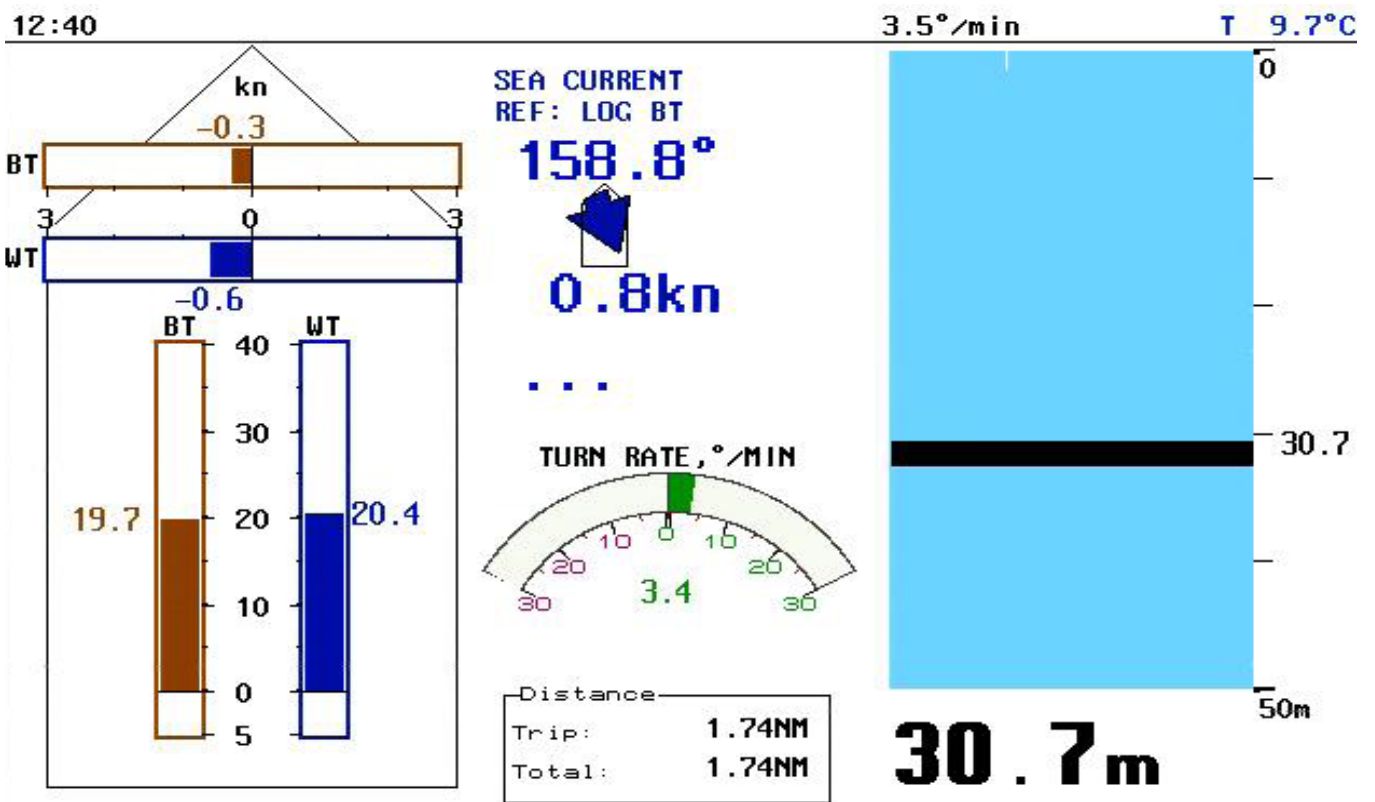

Beam filter

In case the noise test (in “Screen diagnostics”) test failed on one channel this feature will let you filter away the faulty channel and let the speed log operate on the two working channels.

To switch on current function:go to “Screen diagnostics#, “Menu 4”

The current function is visible by pressing “hidden button”and keep it pressed for about 3 seconds (second beep must be heard while pressed).

Default setting “None” for use of all 3 channels

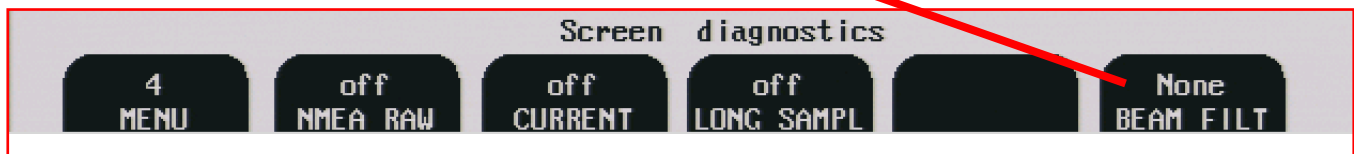

Choose the channel to filter.

In this example the Channel number 1 is filtered. Speed log will operate on channel 3 and 4



Operation of speed log with only two channels will work fine. It may be need for recalibration of heading error.

The only limitation to a two channel operation is the effect from any vertical movement of water in STW. Example: When vessel is moving in water some of the STW speed may come from water being pushed down under the hull resulting in a difference between heading error BT (SOG) and heading error WT (STW).

In operation with only 2 channels there is a reading of “Avaraged drift BT” (brown) in additional to the default normal “Avaraged drift WT” (Blue).

“Heading error BT” button is implemented into the “Screen calibration”, “Menu 3” to set “Avaraged drift BT” to zero.

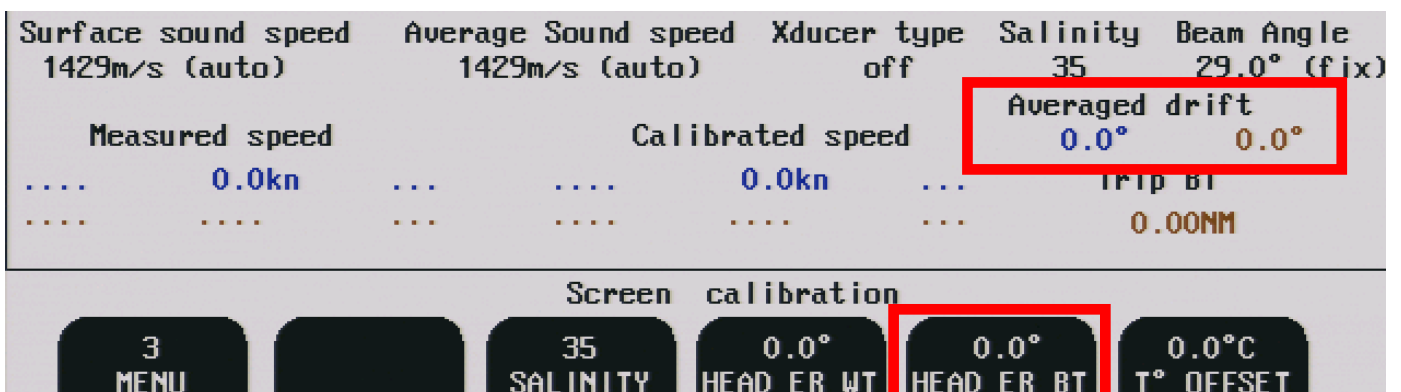

Higher accuracy of depth and speed calculation

The transducer calculates the beam angle into the sea based on type of transducer and sea condition. The calculation of speed and depth will be more accurate with:

- “Xducer Con” set to “A/B” with sensor DL850S27G-SB. “Screen Calibration”, “Menu 4”
- “salinity” “Screen Calibration”, “Menu 3”
- “temperature” Automatic from temperature sensor
- “Sound Surf” “Screen Calibration”, “Menu 4” set to “auto”
- “Sound Surf” “Screen Calibration”, “Menu 4” set to “auto”

Surface sound speed 1523m/s (auto)		Average Sound speed 1523m/s (auto)		Xducer type off	Salinity 35	Beam Angle 29.0° (fix)
Measured speed		Calibrated speed		Averaged drift 26.5°		
1.9kn	0.9kn	25.2°	1.9kn	0.9kn	24.9°	Trip BT
0.1kn	-0.2kn	-73.3°	0.1kn	-0.2kn	-73.3°	0.00NM

Screen calibration



Screen calibration, Menu 4, (3 beeps).

Softkey	Name	Range/value	Default value	Description	Activate with hidden button
1	MENU	1 - 4	3	Menu 4 is selected.	
2	XDUCER CON	“OFF” “A/B” “C” “D”	OFF	Type of transducer installed. Used to calculate the correct beam angle into the sea.	Yes (3 beep)
3					
4					
5	SOUND SURF	1400-1550 m/s	Auto	Speed of sound in water.at surface	Yes (1 beep)
6	SOUND AVER	1400 - 1550 m/s	Auto	Speed of sound in water. Average of STW area	Yes (1 beep)

NAUT rules

The DL850 will, by default, measure the “speed through water” (STW) from doppler effect in water particles in a distance 1 to 15 meters away from sensor. This is depending of depth as area will decrease to avoid bottom signal in shallow water.

The DNV rules for ships NAUT rules says STW is to be measured in a distance 1 to 3 meters away from sensor at all times.



Screen status, Menu 7, (3 beeps)

Softkey	Name	Range/ value	Default value	Description	Activate with hidden button
1	MENU	1 -8	7		
2	SIGN. GOOD	6- 90 %	50 %	Min. sample % to be qualified as good.	Yes (1 beep)
3	SIGN. SUSP(ECTED)	5 - 89 %	25 %	Min. sample % to be qualified as suspected.	Yes (1 beep)
4	Not used			Not used	
5	RESET FACTORY	Reset		Reset of log settings without reset of calibration and I/O settings. (Alternative to Master reset)	Yes (1 beep)
6	NAUT RULES	OFF/ON	OFF	Set area in water were STW is measured. OFF: 1-9ms (Within 15m from sensor depending on bottom depth.) ON: 1-2ms (within 3m distance from sensor)	Yes (3 beeps)

15. Index

Symbols

115/230 V selection on backplane inside Transceiver unit 77
115/230 V selection on Combo Terminal board 37
270 kHz Sensor Cable Connection 73

A

AC Voltage selection 38
Alert relay connections 45
Alerts 9
Analogue interfaces 47
ANA MAX 25
ANA MIN 25
ANA MODE 25
AUTO BT 32, 81

B

Backlight adjustment (brightness) 10
Back-up Battery Jumper JP200 39
BAUD 21
Bottom Track Characteristics 33
BOW<->SENS 24
BT MEASUR. 28
BT NOISE.PK 32
BT REAL 28
BT tCONST 32
Built in test (BIT) 34

C

CALIBR 27
Calibration procedure 51
Calibration routine 52
CALIBR DIS 27
CALIBR NUM 28
COM 20, 21
CPU PCA-6742VE setup 79
Current function 84, 85, 86

D

DATA 21
DAY 24
DIAGNOSTIC 30, 31, 83
Diagnostic functions 34
Dimensional Drawing Cabinet 76
Dimensions 65
dimming 48
DISPLAY 20
DISTANCE 23, 26
DL 850 System Overview 71
Docking Function - Option 33
Docking option parameter setup 24
Doppler Log Principle 33
DPT RANGE 30, 31, 83
DRAUGHT 24

E

EMC 74
Enabling advanced parameters with Hidden button 19
Enabling of calibration 19, 52
Environmental 66
ES MODE 81
ES RANGE 23
EXTENDED SPEED 12
External dimming over NMEA 48

F

Failures 62
Ferrite 74
Fig. 1.1 Operator unit, panel layout. 10
Fig. 4.1 Voltage selection connectors and fuses, Terminal Board. 38
Fig. 4.2 Static Memory Battery Jumper, I/O Board. 39
Fig. 4.3 Function LEDs, on terminal board 40
Fig. 4.5 Terminal connections 43
Fig. 4.6 Misc I/O connections 44
Fig. 4.7 Power failure connections 45
Fig 6.1 Sea valve alignment 51
Fig. 10.1 PCB positions in Transceiver Unit 69
Fig. 10.2 LEDs on PCBs in Transceiver Unit 70
Fig. 10.3. System overview 71
Fig. 10.4. Transceiver unit - operator unit interconnection 72
Fig. 10.5. 270 kHz Sensor Cable Connection 73
Fig. 10.6. Transceiver Unit Dimensions 75
Fig. 10.7. Cabinet Dimensions 76
Fig. 10.8. 115/230 V selection on Transceiver unit backplane 77
FILTER 32
Fixed Key Functions 10
Functional Properties 65
Function LEDs 40
Fuses 38

G

GPS->BT 81

H

Handling warning 36
HEAD ERR 29
Heading Error 51
Heading error correction 53
Hidden button 19
Higher accuracy of depth and speed calculation 85
HOURS 24
HYSTERESIS 26

I

Important note 32, 37, 41, 64
INDICATION 15, 16
Inputs 9, 47

Installation 36
 Installation Diagrams 68
 Installation of bottom parts/transducer 36
 Installation problems 57
 Interface problems 58
 Interfacing 9
 Introduction 6, 7

L

LANGUAGE 23
 LEDs on PCBs in Transceiver Unit 70
 Link to Transceiver 60
 Log Pulse Outputs 46
 LONG. SP 26

M

Manual speed calibration 53
 Master reset procedure 64
 MEAN VALUE 31
 MENU 12, 13, 20, 21, 23, 24, 25, 26, 27, 28, 30, 31, 32, 83
 MESSAGE 20
 MINUTES 24
 mportant note 63

N

NAUT rules 86
 NMEA interface 47, 48
 NMEA-Raw 83
 NMEA sentences transmitted 48
 NMEA Setup 48
 Non-volatile Parameter Memory 33
 NOT CALIBRATED WT BT 27
 Note 17, 21, 23, 24, 26, 27, 35, 37, 39, 46, 47, 55, 57, 62, 64,
 66, 78, 80

O

Operation 10
 Operator Unit 9
 Operator Unit and Transceiver Unit Maintenance 35
 Operator Unit Installation 37
 Operator unit, panel layout. 10
 Operator unit - Terminal connections 43
 Operator Unit - Transceiver Unit Interconnection 72
 Options 47
 OUT MODE 25
 OUT NUM 25
 OUTPUT 20
 Outputs 9

P

Parameter entry 11
 PCB positions in Transceiver Unit 69
 Performance 65
 Power failure relay 45
 Power indication 40
 Primary Screens 11

Principal Functions 33
 PULSES NUM 25

R

Receiver PLD rev: 0.0.00 41
 RECORDINGS 30, 31, 83
 Repeaters/Slaves 47
 RESET FACTORY 26
 Reset factory procedure 64
 Run Aver 32

S

SALINITY 29
 Scope 34
 SCOPE 31
 Screen calibration, Menu 1, calibration. 27
 Screen calibration, Menu 2, manual override. 28
 Screen calibration, Menu 3, mounting settings. 29, 85
 Screen calibration, Menu 4, mounting settings. 29, 85
 Screen com, Menu 1, NMEA setup. 20
 Screen com, Menu 2, NMEA com setup. 21
 Screen diagnostics, Menu 1. 30, 31, 83
 Screen diagnostics, Menu 1, Details Off. 30
 Screen diagnostics, Menu 1, Details On 31
 Screen diagnostics, Menu 2, filtering/averaging. 32
 Screen diagnostics, Menu 3, settings 32
 Screen docking, arrow view (only in docking version). 15
 Screen docking, bar graph view (only in docking version). 16
 Screen open sea, system. 17
 Screen pilot, Menu 1, trip reset. 12
 Screen pilot, Menu 2, system. 13
 Screen Select 10
 Screen shallow water, (only in non docking version). 14
 Screen status, Menu 1, units. 23
 Screen status, Menu 2, date/time. 24
 Screen status, Menu 3, boat setup/buzzer. 24
 Screen status, Menu 4, pulse settings. 25
 Screen status, Menu 5, analogue settings. 25
 Screen status, Menu 6, speed limits and hysteresis 26
 Screen status, Menu 7, signal good/signal suspected 26, 86
 Screen status, Menu 8, speed test/demo (simulate). 26
 Sea valve alignment 51
 Semi Automatic calibration 54
 Sensor to bow 24
 Sensor (Transducer) and Transceiver 8
 Service 67
 Setup and Function Control Screens 18
 SHIP LEN 24
 Ship length 24
 Signal longitudinal & signal transversal 60
 SIGN. GOOD 26
 SIGN. SUSP(ECTED) 26
 SIMULATE 26
 SL BT MODE 32, 81
 SOUND 29, 85
 SOUND SPD 23
 SOUND SURF 29, 85

SPD LIMIT 26
SPD TEST 26
Speed Limit function 46
Standard System Supply 36
START 27
System 23
SYSTEM 12, 13, 14, 15, 16, 17
System Summary 6, 7

T

Temperature 60
The echo sounder function 80, 82
T° OFFSET 29
Transceiver unit 8
Transceiver Unit Dimensions 74, 75
Transducer Installation 36
Transducer Maintenance 35
TRANSV. SP 26
TRIP 12
TRIP BT 27
trip reset 48
Trip reset 48
TRIPS LIST 27
Trouble Shooting 56

U

Upgrading Software 78
User Maintenance 35

V

VESSEL SPD 23

W

Water Track Characteristics 33
WT MEASUR. 28
WT NOIS.PK 32
WT REAL 28
WT tCONST 32

X

XDUCER CON 85

Y

YR.MONTH 24